



Grayhill, Inc.

62S11-L0-020CH

Dio brojeva:

Proizvođač / robna marka:

Opis proizvoda

Liste podataka:

Status RoHS

Stanje zaliha

Brod od

Put pošiljke

62S11-L0-020CH

Grayhill, Inc.

ROTARY ENCODER OPTICAL 32PPR

 62S11-L0-020CH.pdf

 Ne sadrži olovo / RoHS sukladnost

2105 pcs stock

Hong Kong

DHL/Fedex/TNT/UPS/EMS

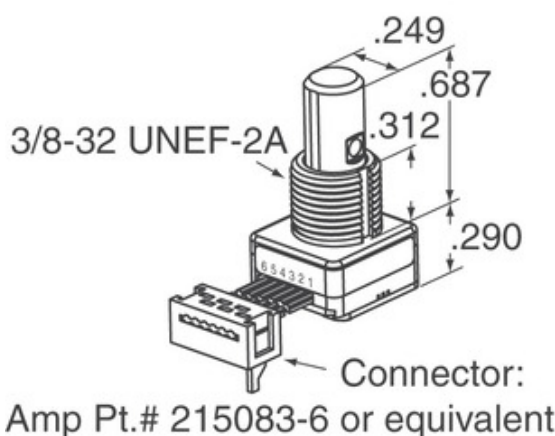

Slika može biti reprezentativna. Pogledajte specifikacije za pojedinosti o proizvodu.



Specifikacije 62S11-L0-020CH

DIO BROJEVA	62S11-L0-020CH
PROIZVOĐAČ	Grayhill, Inc.
OPIS	ROTARY ENCODER OPTICAL 32PPR
STATUS SLOBODNOG OLOVA / ROHS-A	Ne sadrži olovo / RoHS sukladnost
RASPOLOŽIVA KOLIČINA	2105 pcs
OBRAZAC PODATAKA	 62S11-L0-020CH.pdf
NAPAJANJE	5V
STIL ZAVRŠETKA	Cable with Connector
NIZ	62S
ROTACIJSKI ŽIVOT (CIKLUSI MIN)	1M
PULSE PO REVOLUCIJI	32
VRSTA IZLAZA	Quadrature (Incremental)
DRUGA IMENA	62S11L0020CH
ORIJENTACIJA	Vertical
VRSTA MONTAŽE	Panel Mount
RAZINA OSJETLJIVOSTI VLAGE (MSL)	1 (Unlimited)
STATUS SLOBODNOG OLOVA / ROHS-A	Lead free / RoHS Compliant
VRSTA DAVAČA	Optical
ZAPONSKA	Yes
UGRAĐENI PREKIDAČ	No
VRSTA POGONA	1/4" Dia Flatted End

Povezane oznake

Grayhill, Inc. 62S11-L0-020CH	Distributer 62S11-L0-020CH	Dobavljač 62S11-L0-020CH
Cijena 62S11-L0-020CH	Slike 62S11-L0-020CH	Slika 62S11-L0-020CH
62S11-L0-020CH PDF Datasheet	62S11-L0-020CH Preuzmite podatkovni list	62S11-L0-020CH Datasheet
Stock 62S11-L0-020CH	Kupi 62S11-L0-020CH	Kupi Grayhill, Inc. 62S11-L0-020CH
Grayhill, Inc. 62S11-L0-020CH	Dobavljač Grayhill, Inc.	Grayhill, Inc. Distributer
Grayhill, Inc. 62S11-L0-020CH	Grayhill Inc. 62S11-L0-020CH	

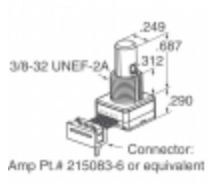
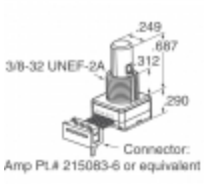
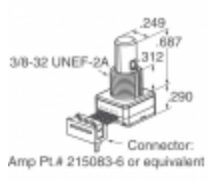
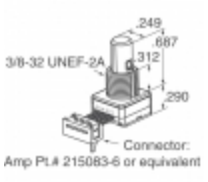
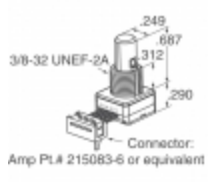
Povezani proizvodi

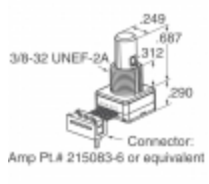
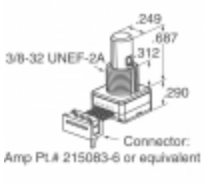
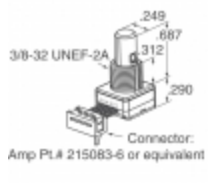
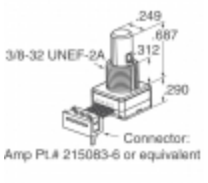
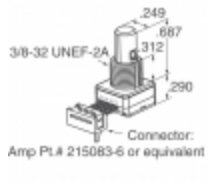
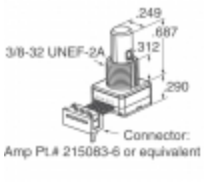
 <p>62S11-H9-P Proizvođači: Grayhill, Inc. Opis: ROTARY ENCODER OPTICAL 32PPR Na lageru: 2159 pcs</p> <p>RFQ</p>	 <p>62S11-L0-060S Proizvođači: Grayhill, Inc. Opis: ROTARY ENCODER OPTICAL 32PPR Na lageru: 2241 pcs</p> <p>RFQ</p>
 <p>62S11-H9-PH Proizvođači: Grayhill, Inc. Opis: ROTARY ENCODER OPTICAL 32PPR Na lageru: 2090 pcs</p> <p>RFQ</p>	 <p>62S11-L0-020C Proizvođači: Grayhill, Inc. Opis: ROTARY ENCODER OPTICAL 32PPR Na lageru: 1839 pcs</p> <p>RFQ</p>
 <p>62S11-L0-055C Proizvođači: Grayhill, Inc. Opis: ROTARY ENCODER OPTICAL 32PPR Na lageru: 1995 pcs</p> <p>RFQ</p>	 <p>62S11-L0-040S Proizvođači: Grayhill, Inc. Opis: ROTARY ENCODER OPT 32PPR 4" CBL Na lageru: 2058 pcs</p> <p>RFQ</p>
 <p>62S11-H9-060SH Proizvođači: Grayhill, Inc. Opis: ROTARY ENCODER OPTICAL 32PPR Na lageru: 1966 pcs</p> <p>RFQ</p>	 <p>62S11-L0-040C Proizvođači: Grayhill, Inc. Opis: ROTARY ENCODER OPTICAL 32PPR Na lageru: 2079 pcs</p> <p>RFQ</p>
 <p>62S11-H9-050S Proizvođači: Grayhill, Inc. Opis: ROTARY ENCODER OPTICAL 32PPR Na lageru: 1839 pcs</p> <p>RFQ</p>	 <p>62S11-H9-060C Proizvođači: Grayhill, Inc. Opis: ROTARY ENCODER OPTICAL 32PPR Na lageru: 2172 pcs</p> <p>RFQ</p>
 <p>62S11-L0-060SH Proizvođači: Grayhill, Inc. Opis: ROTARY ENCODER OPTICAL 32PPR Na lageru: 2073 pcs</p> <p>RFQ</p>	 <p>62S11-L0-060CH Proizvođači: Grayhill, Inc. Opis: ROTARY ENCODER OPTICAL 32PPR Na lageru: 1935 pcs</p> <p>RFQ</p>

Copyright © 2020 Pouzdan distributer elektroničkih komponenti

E-mail: Info@infinity-electronic.com

Adresa: 17F, poslovna zgrada Gaylord, 114-118 Lockhart Road, Wan Chai, Hong Kong

