



Grayhill, Inc.

62S11-N9-060C

Dio brojeva:

62S11-N9-060C

Proizvođač / robna marka:

Grayhill, Inc.

Opis proizvoda

ROTARY ENCODER OPTICAL 32PPR

Liste podataka:

 62S11-N9-060C.pdf

Status RoHS

 Ne sadrži olovo / RoHS sukladnost

Stanje zaliha

2192 pcs stock

Brod od

Hong Kong

Put pošiljke

DHL/Fedex/TNT/UPS/EMS

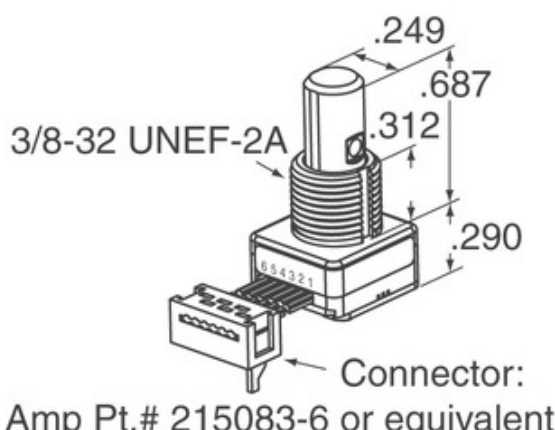

Connector:
Amp Pt.# 215083-6 or equivalent

[ZAHTJEV ZA PONUDU](#)

Slika može biti reprezentativna. Pogledajte specifikacije za pojedinosti o proizvodu.







Specifikacije 62S11-N9-060C

DIO BROJEVA	62S11-N9-060C
PROIZVOĐAČ	Grayhill, Inc.
OPIS	ROTARY ENCODER OPTICAL 32PPR
STATUS SLOBODNOG OLOVA / ROHS-A	Ne sadrži olovo / RoHS sukladnost
RASPOLOŽIVA KOLIČINA	2192 pcs
OBRAZAC PODATAKA	 62S11-N9-060C.pdf
NAPAJANJE	5V
STIL ZAVRŠETKA	Cable with Connector
NIZ	62S
ROTACIJSKI ŽIVOT (CIKLUSI MIN)	1M
PULSE PO REVOLUCIJI	32
VRSTA IZLAZA	Quadrature (Incremental)
DRUGA IMENA	62S11N9060C
ORIJENTACIJA	Vertical
VRSTA MONTAŽE	Panel Mount
RAZINA OSJETLJIVOSTI VLAGE (MSL)	1 (Unlimited)
STATUS SLOBODNOG OLOVA / ROHS-A	Lead free / RoHS Compliant
VRSTA DAVAČA	Optical
ZAPONSKA	No
UGRAĐENI PREKIDAČ	Yes
VRSTA POGONA	1/4" Dia Flatted End

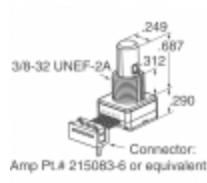
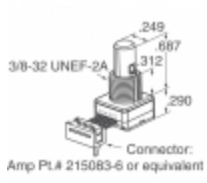
Povezane oznake

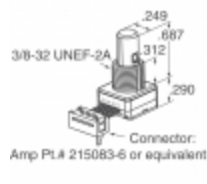
Grayhill, Inc. 62S11-N9-060C	Distributer 62S11-N9-060C	Dobavljač 62S11-N9-060C
Cijena 62S11-N9-060C	Slike 62S11-N9-060C	Slika 62S11-N9-060C
62S11-N9-060C PDF Datasheet	62S11-N9-060C Preuzmite podatkovni list	62S11-N9-060C Datasheet
Stock 62S11-N9-060C	Kupi 62S11-N9-060C	Kupi Grayhill, Inc. 62S11-N9-060C
Grayhill, Inc. 62S11-N9-060C	Dobavljač Grayhill, Inc.	Grayhill, Inc. Distributer
Grayhill, Inc. 62S11-N9-060C	Grayhill Inc. 62S11-N9-060C	

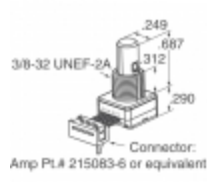
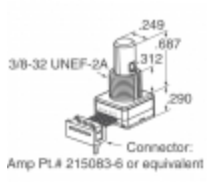
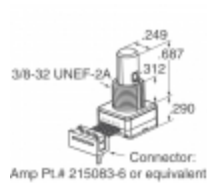
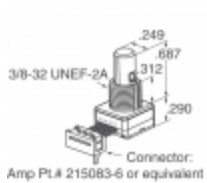
Povezani proizvodi

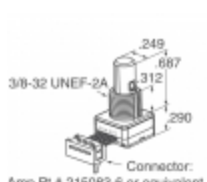
 <p>62S11-N5-060SH Proizvođači: Grayhill, Inc. Opis: ROTARY ENCODER OPTICAL 32PPR Na lageru: 2263 pcs</p> <p>RFQ</p>	 <p>62S11-N9-060SH Proizvođači: Grayhill, Inc. Opis: ROTARY ENCODER OPTICAL 32PPR Na lageru: 1801 pcs</p> <p>RFQ</p>
 <p>62S15-H0-020C Proizvođači: Grayhill, Inc. Opis: ROTARY ENCODER OPTICAL 24PPR Na lageru: 2286 pcs</p> <p>RFQ</p>	 <p>62S15-H0-040CH Proizvođači: Grayhill, Inc. Opis: ROTARY ENCODER OPTICAL 24PPR Na lageru: 1921 pcs</p> <p>RFQ</p>
 <p>62S11-N5-080SH Proizvođači: Grayhill, Inc. Opis: ROTARY ENCODER OPTICAL 32PPR Na lageru: 1942 pcs</p> <p>RFQ</p>	 <p>62S11-N5-PV Proizvođači: Grayhill, Inc. Opis: ROTARY ENCODER OPTICAL 32PPR Na lageru: 2220 pcs</p> <p>RFQ</p>
 <p>62S11-N9-PH Proizvođači: Grayhill, Inc. Opis: ROTARY ENCODER OPTICAL 32PPR Na lageru: 2219 pcs</p> <p>RFQ</p>	 <p>62S11-N5-100C Proizvođači: Grayhill, Inc. Opis: ROTARY ENCODER OPTICAL 32PPR Na lageru: 1789 pcs</p> <p>RFQ</p>
 <p>62S11-N9-120S Proizvođači: Grayhill, Inc. Opis: ROTARY ENCODER OPTICAL 32PPR Na lageru: 1784 pcs</p> <p>RFQ</p>	 <p>62S11-N5-120S Proizvođači: Grayhill, Inc. Opis: ROTARY ENCODER OPTICAL 32PPR Na lageru: 1675 pcs</p> <p>RFQ</p>
 <p>62S15-H0-040C Proizvođači: Grayhill, Inc. Opis: ROTARY ENCODER OPTICAL 24PPR Na lageru: 1793 pcs</p> <p>RFQ</p>	 <p>62S11-N5-P Proizvođači: Grayhill, Inc. Opis: ROTARY ENCODER OPTICAL 32PPR Na lageru: 1885 pcs</p> <p>RFQ</p>

Copyright © 2020 Pouzdan distributer elektroničkih komponenti

E-mail: Info@infinity-electronic.com

Adresa: 17F, poslovna zgrada Gaylord, 114-118 Lockhart Road, Wan Chai, Hong Kong

