



## Evaluation kit for Multimedia Bluetooth® Modules Datasheet

### GENERAL DESCRIPTION

>> F2M03M-KIT is the newly developed evaluation kit for Free2move's multimedia Bluetooth modules. The evaluation board has extensive I/O functionality for both data and stereo audio streams. The evaluation board is primarily made to evaluate the Wireless Audio firmware but is also intended to be used for other firmwares and custom made applications. The evaluation board gives the possibility to upgrade the Bluetooth module with new firmware using Free2move's Flash utility.

>> HiFi stereo audio streams can be connected in many different ways; using the linear audio connector (line in, speaker and microphone with 3.5mm sockets), SPDIF or connect the audio to an external codec using the PCM interface with the possibility to use many different digital audio protocols.

>> The F2M03M-KIT has both RS232 and USB-interface for data communication. The USB-interface can either act as a direct connection to the module through HCI or it can be used as a virtual com port for computers without a physical com port. All digital and analog I/O:s can be accessed from pin headers on the evaluation board for external communication.

>> The F2M03M-KIT is delivered with all necessary cables, a stereo headset and a CD with manuals and software. The kit does NOT include any Bluetooth OEM-board. They need to be ordered separately!

### KEY FEATURES

- >> 10 GPIO:s with push buttons and leds
- >> SPDIF-interface (input and output)
- >> Analog stereo audio interface (line in, speaker and mic)
- >> Power supply through USB-connector or external adaptor
- >> USB-interface
- >> RS232-interface
- >> Programming interface for Free2move's flash utility
- >> Pin headers for all digital and analog I/O:s

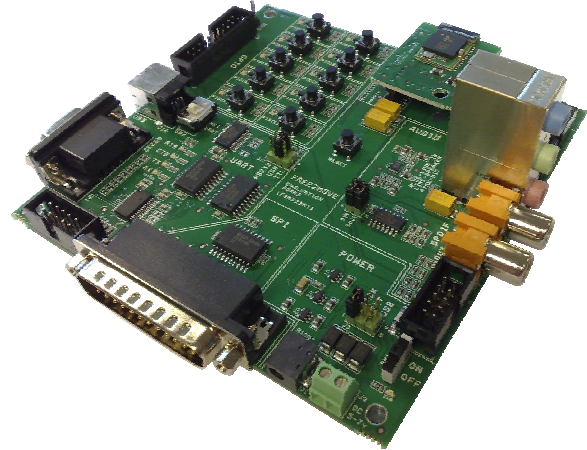

Image of the Evaluation board with a F2M03MLA module

### F2M03M-KIT-1 CONTAINS

- >> F2M02BG1 (Evaluation board)
- >> USB cable
- >> Serial cable
- >> Parallel cable
- >> Stereo Headset
- >> CD (Manuals and software)

### ORDER INFORMATION

- >> Evaluation kit:
  - > F2M03M-KIT-1
- >> Bluetooth OEM-board:
  - > F2M02MLA-S03-K  
(OEM-board with a F2M03MLA module, Pin sockets and Wireless Audio Headset firmware)



BLUETOOTH is a trademark owned by Bluetooth SIG, Inc., U.S.A. and licensed to Free2move



## Evaluation kit for Multimedia Bluetooth™ Modules Datasheet

---

### Table of contents

<b>1</b>	<b>Package content .....</b>	<b>3</b>
<b>2</b>	<b>Quick getting started guide .....</b>	<b>4</b>
<b>3</b>	<b>Device terminal description .....</b>	<b>5</b>
3.1	GPIO .....	5
3.2	UART .....	6
3.3	SPI .....	8
3.4	Power supply .....	9
3.5	Audio .....	10
3.6	Bluetooth module connector .....	11
3.7	Host Controlled Interface (HCI) .....	12
<b>4</b>	<b>Layout .....</b>	<b>13</b>
<b>5</b>	<b>Schematics .....</b>	<b>14</b>
<b>6</b>	<b>Bill of materials .....</b>	<b>15</b>
<b>7</b>	<b>Ordering information .....</b>	<b>17</b>
<b>8</b>	<b>Document history .....</b>	<b>18</b>
	<b>Acronyms and definitions.....</b>	<b>19</b>



## Evaluation kit for Multimedia Bluetooth™ Modules Datasheet

### 1 Package content

Please make sure that the package contains the following:

- Evaluation board F2M02BM1
- Stereo Headset (HL-7)
- CD with all necessary software and user manuals

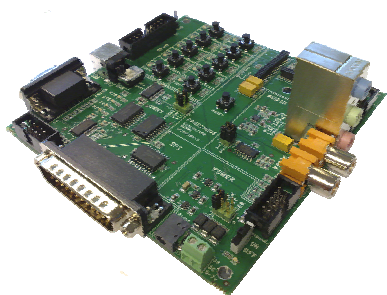

- 1m USB-cable (USB-210)
- 2m 9pin serial cable (DEL-37)
- 2m 25pin parallel cable (DEL-20)





## Evaluation kit for Multimedia Bluetooth™ Modules Datasheet

### 2 Quick getting started guide

1. Unpack and check that the package contains all items.
2. Gently attach the OEM Bluetooth™ board onto the connectors at the top of the evaluation board. The OEM-board should be placed in such a way that the big drilled hole on both the Evaluation-kit and the OEM-board matches each other and all headers are aligned to the corresponding socket. The antenna (or connector) on the OEM-board should point away from the evaluation board.
3. Connect the stereo headset as shown in the image below (Speaker – lime, Microphone – Pink)

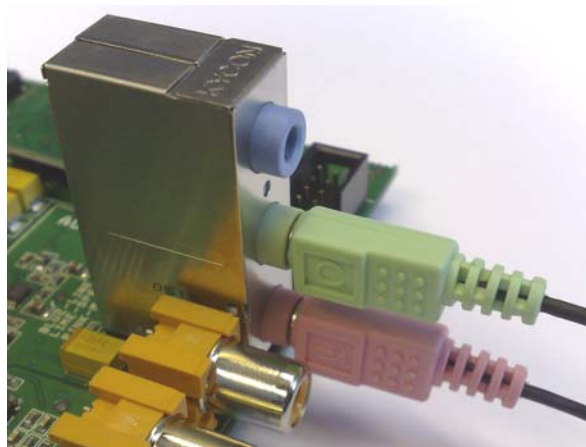
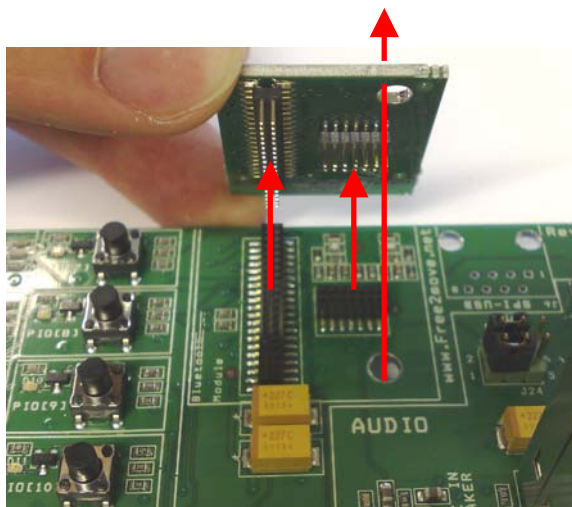

4. Connect the USB-cable provided with the kit between your computer and the evaluation board.
5. Powers up the evaluation board by moving switch SW1 to the ON-position.
6. You should now see the screen “found new hardware” (under windows XP) and the installation of the USB-to-Serial port driver for the Evaluation board begins. Please look at the provided CD for installation instructions from FTDI.\*
7. You now have the basic configuration to be able to start using the evaluation board.
8. Please look at the specific firmware datasheet for more information about the functionality of the module.

**Look at the CD for more information about the applications provided with this kit!**

The above “quick getting started guide” is only a brief explanation of how you can configure the evaluation kit. You have all possibilities to use any interface you like, connecting external devices, change the firmware on the module, change the power source etc. Feel free to use the evaluation kit to fit your application and needs!

\* The Evaluation board has a maximum current consumption of 400mA and can in some cases be too much to be powered from a computer and especially notebooks. If this is the case, use the DC-Jack or the terminal block to power up the evaluation board.



## Evaluation kit for Multimedia Bluetooth™ Modules Datasheet

### 3 Device terminal description

All terminals available on the evaluation board are presented in this chapter. The image below is showing the different parts of the board.

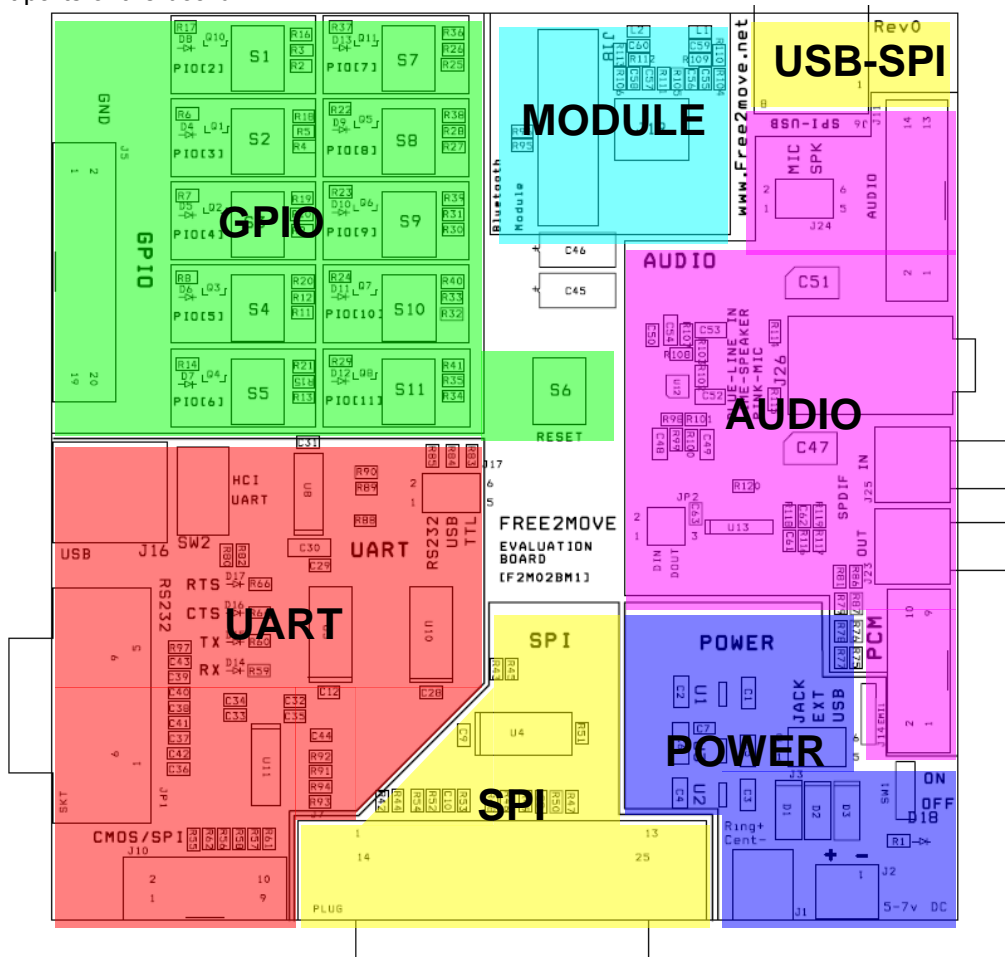

#### 3.1 GPIO

The board is equipped with 10 pushbuttons/leds for general evaluation purposes. The buttons and leds are active high. All GPIOs from the module are also available on connector J5, which have CMOS levels (0v-3v3). The reset button is located in the middle of the board and will, if pushed down, reset the Bluetooth module. The GND-pin is directly connected to the digital ground of the board and can be used for measurement purposes.

Connector J5 pinout:

Pin	Description	Direction
1	GND	GND
2	+3v3	OUT
3	AIO[1]	I/O
4	AIO[2]	I/O
5	AIO[0]	I/O
6	AIO[3]	I/O
7	GND	GND
8	GND	GND
9	PIO[0]	I/O
10	PIO[11]	I/O

Pin	Description	Direction
11	PIO[1]	I/O
12	PIO[10]	I/O
13	PIO[2]	I/O
14	PIO[9]	I/O
15	PIO[3]	I/O
16	PIO[8]	I/O
17	PIO[4]	I/O
18	PIO[7]	I/O
19	PIO[5]	I/O
20	PIO[6]	I/O



## Evaluation kit for Multimedia Bluetooth™ Modules Datasheet

### 3.2 UART

It is possible to connect the UART on the module in three different ways. Either via USB, RS232 or connect it directly without any level-converters (CMOS-levels). The default UART interface is USB at delivery but can easily be changed by changing the jumper on connector J17.

#### 3.2.1 USB

The evaluation board is equipped with an USB-to-UART converter from FTDI making it possible to send UART data over the USB-interface by emulate a com-port (Presented as a Virtual Com Port on the computer). Before you install the drivers or try to communicate with the module, please make sure that J17 has the jumper attached at the USB marking and switch SW2 is in the UART position.

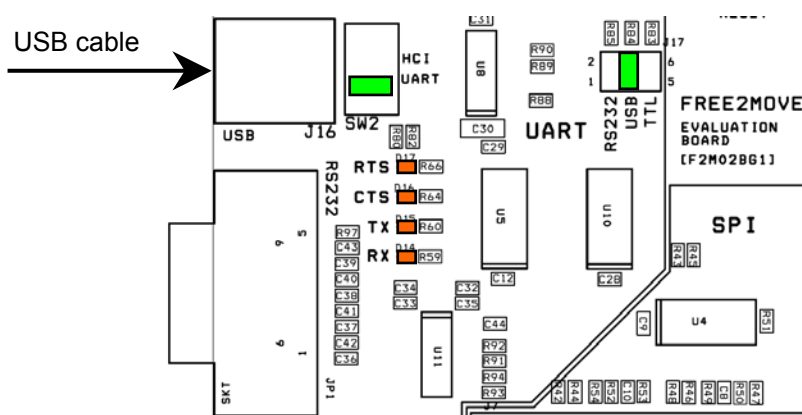

Image of the required settings for UART interface via USB

The first step is to install the Virtual Com Port (VCP) drivers supplied on the CD that comes with this kit. Installation documentation for the VCP is supplied on the CD.

When the driver is installed, you should be able to send and receive UART data from the module via the USB-interface. Note that it is also possible to power supply the evaluation board through the USB-connector. The different power supply possibilities are presented in section [3.4](#).

Four status leds are indicating the activity of the UART signals. All signals are seen from the connected device perspective, meaning that i.e. if the RX led is flashing, the Bluetooth module transmits data and the connected device is *receiving data* (RX).

#### Status leds

Signal	LED on	LED off
RTS	The connected device is ready to receive data	The connected device is not ready to receive data
CTS	The Bluetooth module is ready to receive data	The Bluetooth module is not ready to receive data
TX	The connected device is Transmitting data	IDLE
RX	The connected device is Receiving data	IDLE

The USB-connector is also used to communicate with the module via HCI (Host Controlled Interface) and this is made by setting SW2 in the HCI position. Please look at section [3.7](#) for more information about HCI.



## Evaluation kit for Multimedia Bluetooth™ Modules Datasheet

### 3.2.2 RS232

Moving the jumper on connector J17 to the RS232-position enables the RS232 interface.

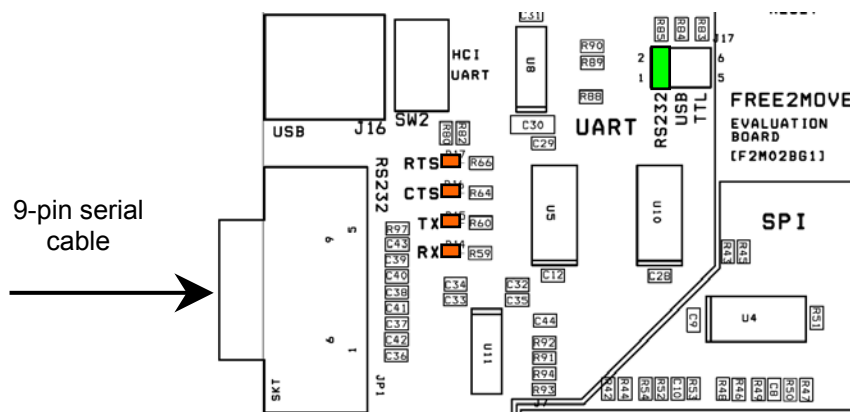

The RS232 interface can be used with a computer or other peripheral device that have a com-port. It is possible to connect the board to a computer (DTE-device) with a straight cable provided with the kit. The evaluation board acts as a DCE-device with the following pinout (seen from the D-sub):

9-pin D-SUB RS232 (JP1)

Pin	Description	Direction
1	DCD	OUT
2	TX	OUT
3	RX	IN
4	DTR	IN
5	GND	GND
6	DSR	OUT
7	RTS	IN
8	CTS	OUT
9	RI	OUT

The four status leds have the same function as described in the USB section.

### 3.2.3 CMOS

The third option to communicate with the Bluetooth device over the UART is via CMOS-levels (0-3v3). This is most likely when you want to communicate with a microcontroller or other device without using any level converters such as the USB or RS232-interface. The signals are available on connector J10 and are enabled by moving the jumper on connector J17 to the TTL (CMOS) position. The four status leds have the same function as described in the USB section.



## Evaluation kit for Multimedia Bluetooth™ Modules Datasheet

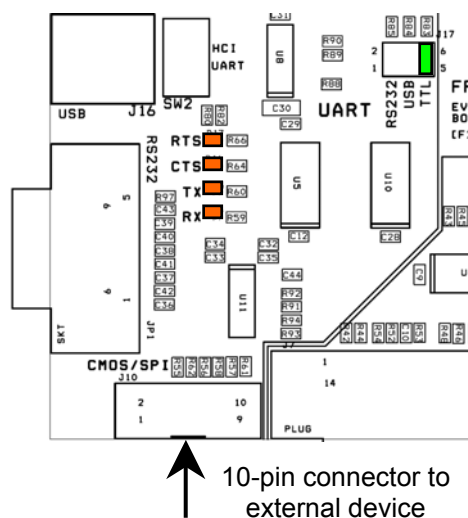

The pinout of the connector is presented in the table below (The SPI-signals should not be connected).

Pinout of connector J10 (CMOS/SPI)

Pin	Description	Direction
1	SPI_CS	I/O
2	SPI_MISO	I/O
3	SPI_MOSI	I/O
4	SPI_CLK	OUT
5	+3v3	OUT
6	GND	GND
7	TX	OUT
8	CTS	IN
9	RTS	OUT
10	RX	IN

### 3.3 SPI

Free2move offers the possibility to upgrade the firmware on the module via the SPI-interface. You will be able to access the module with Free2move's Flash utility provided on the CD. The program is made to easy configure and upgrade the firmware on the module. The evaluation board can only be connected to a computer via the parallel port but it will hopefully be possible connect the board via USB in the future (at connector J6) but this will involve an external SPI-to-USB converter, which is not ready yet.

It is also possible to use the evaluation board to upgrade modules on a custom PCB by routing out the SPI-signals on the PCB and connect it to connector J10. Be sure to detach any Bluetooth module from the OEM-board connector (J18, J19) before you connect an external module.

**Note:** It is highly recommended to route out the SPI-signals from the Bluetooth module on your custom made PCB to be able to upgrade the firmware in the future!

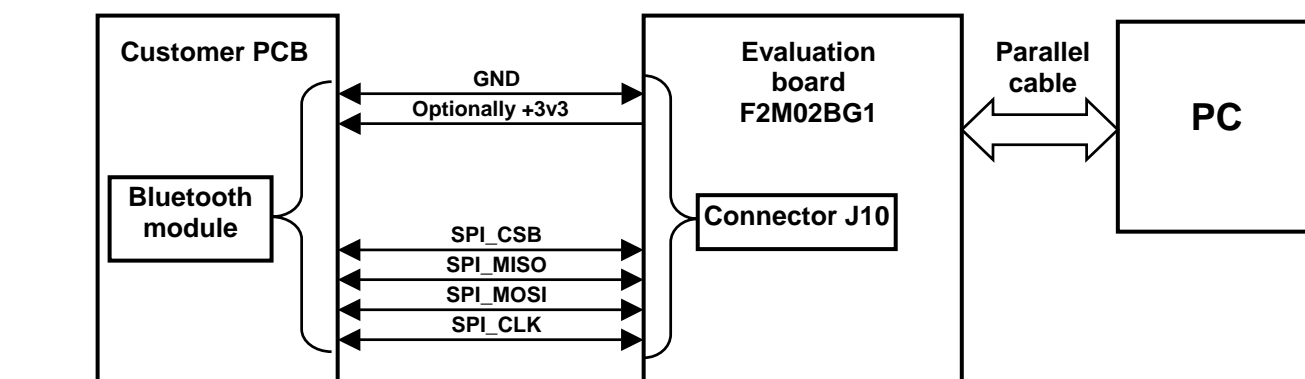





## Evaluation kit for Multimedia Bluetooth™ Modules Datasheet

Pin	Description	Direction
1	SPI_CSB	I/O
2	SPI_MISO	I/O
3	SPI_MOSI	I/O
4	SPI_CLK	I/O
5	+3v3	OUT
6	GND	GND
7	TX	OUT
8	CTS	IN
9	RTS	OUT
10	RX	IN

### 3.4 Power supply

The evaluation board has three separate power supplies for all functionality on the board. The board can be powered in three different ways, either through the USB-interface (default), the DC-jack or via the terminal block (EXT). The different options is presented in the figure below:

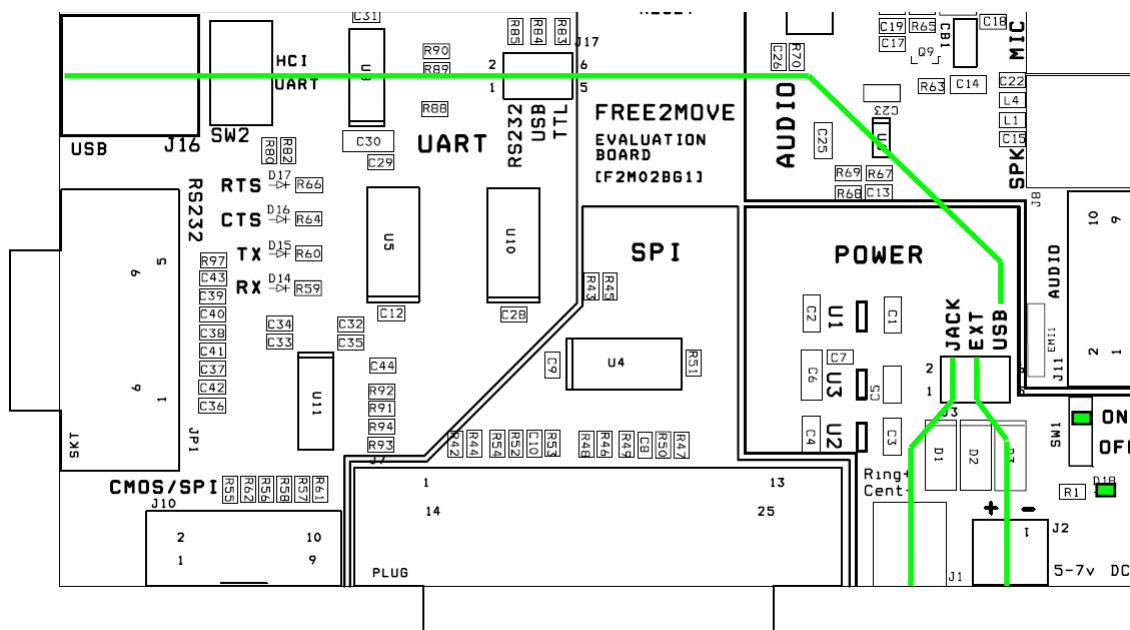

The preferred power source is selected by moving the jumper on connector J3 and the power is applied when moving switch SW1 to the ON position. A green led beneath the switch is indicating when the power is on. The Supplied voltage must be: 5-7v DC, minimum 400mA.

**Note:**

- Be sure to check the polarity before connecting the power to the board!
- The USB port on some computers (especially notebooks) might not deliver the required current to the Evaluation board and will then not power up the entire board (The green power led will still shine but you will not be able to communicate with the module). Please use an external power source if this is the case!
- It is not possible to power the board over the USB-interface if you are using a HCI-firmware (Switch SW2 is in the "HCI" position)



## Evaluation kit for Multimedia Bluetooth™ Modules Datasheet

### 3.5 Audio

The evaluation board is designed for high quality stereo audio and has many different interfaces to connect external devices. Connector J26 has three 3.5mm stereo audio jacks for Line in, Speaker and Microphone. The jumpers on the pin header J24 have to be changed between Mic or Line in for the specific interface used. The board also has a digital audio interface (SPDIF) with digital audio in/out. Connect the external digital audio device to the coaxial connectors (75Ω impedance) J23 (OUT) and J25 (IN) and be sure to have the two jumpers attached on pin header JP2 to enable the SPDIF-interface. All analogue audio signals are available at connector J11 and all digital audio signals are available at connector J14. The digital signals from the Bluetooth module can be used if the two jumpers are removed from the pin-header JP2.

**Note:** The audio interface available is upon firmware support. Please look at the specific firmware datasheet for the module for more information.

J11 (Analogue audio)

Pin	Description	Direction
1	GND	GND
2	+3v3 Analog	OUT
3	IN_RIGHT_N	IN
4	OUT_RIGHT_P	OUT
5	IN_RIGHT_P	IN
6	OUT_RIGHT_N	OUT
7	GND	GND
8	GND	GND
9	IN_LEFT_N	IN
10	OUT_LEFT_P	OUT
11	IN_LEFT_P	IN
12	OUT_LEFT_N	OUT
13	AUX_DAC	I/O
14	GND	GND

J14 (Digital audio)

Pin	Description	Dir.
1	GND	GND
2	PCM_IN/ SPDIF_IN/ SD_IN	IN
3	GND	GND
4	PCM_OUT/ SPDIF_OUT/ SD_OUT	OUT
5	GND	GND
6	PCM_CLK/ SCK	I/O
7	GND	GND
8	PCM_SYNC/ WS	I/O
9	GND	GND
10	GND	GND

J26 (LINE, SPK, MIC)

Pin	Desc.	Dir.
<b>LINE IN</b>		
1	GND	GND
2	RIGHT	IN
3	NC	-
4	LEFT	IN
<b>SPEAKER</b>		
1	GND	GND
2	RIGHT	OUT
3	NC	-
4	LEFT	OUT
<b>MICROPHONE</b>		
1	GND	GND
2	RIGHT	IN
3	NC	-
4	LEFT	IN

J24 / JP2 (Jumpers)

Signal	Jumper on	Jumper off
<b>J24</b>		
MIC	Bias voltage applied to drive a dielectric mic	Differential input
LINE	Negative terminal tied to GND (single ended)	Differential input
<b>JP2</b>		
DIN	Digital signal in routed to SPDIF-interface	SPDIF-interface disabled
DOU	Digital signal out routed to SPDIF-interface	SPDIF-interface disabled



Connector J26



Connector J23, J25



## Evaluation kit for Multimedia Bluetooth™ Modules Datasheet

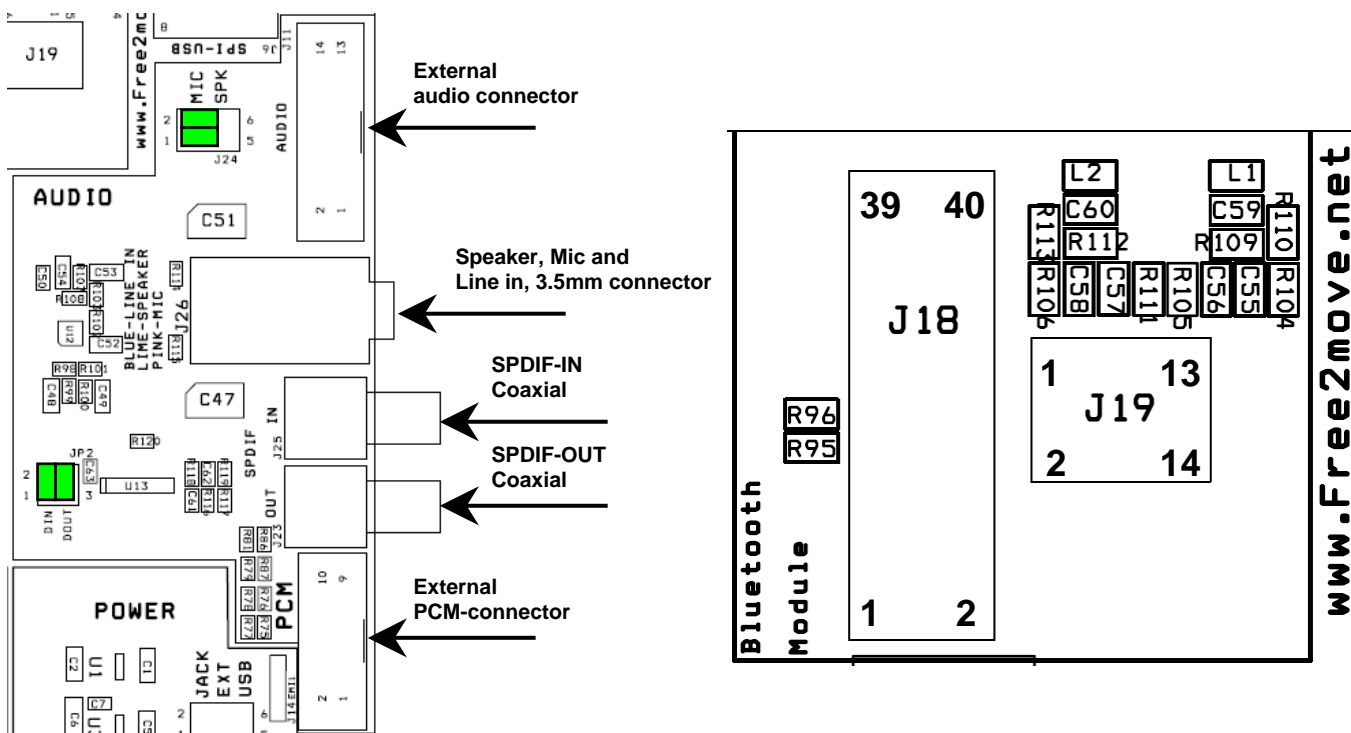

### 3.6 Bluetooth module connector

Connector J18 and J19 are used to attach a Free2move Bluetooth OEM-board. Gently attach the OEM Bluetooth board onto the connectors at the top of the evaluation board. The OEM-board should be placed in such a way that the big drilled hole on both the Evaluation-kit and the OEM-board matches each other and all headers are aligned to the corresponding socket. The antenna (or connector) on the OEM-board should point away from the evaluation board.

Connector J18 (Bluetooth module)

Pin nr	Description	Direction
1	+VCC_BT	Power
2	GND	GND
3	+VCC_PA	Power
4	SPI_CLK	I/O
5	/RESET	IN
6	SPI_MISO	I/O
7	GND	GND
8	SPI_MOSI	I/O
9	TX	OUT
10	SPI_CSB	I/O
11	RX	IN
12	GND	GND
13	CTS	OUT
14	PCM_CLK	I/O
15	RTS	IN
16	PCM_OUT	OUT
17	USB-	I/O
18	PCM_SYNC	I/O
19	USB+	I/O
20	PCM_IN	IN

Pin nr	Description	Direction
21	GND	GND
22	GND	GND
23	PIO[5]	GPIO
24	PIO[6]	GPIO
25	PIO[4]	GPIO
26	PIO[7]	GPIO
27	PIO[3]	GPIO
28	PIO[8]	GPIO
29	PIO[2]	GPIO
30	PIO[9]	GPIO
31	PIO[1]	GPIO
32	PIO[10]	GPIO
33	PIO[0]	GPIO
34	PIO[11]	GPIO
35	GND	GND
36	GND	GND
37	AIO[0]	GPIO
38	AIO[3]	GPIO
39	AIO[1]	GPIO
40	AIO[2]	GPIO

Connector J19 (Bluetooth module)

Pin nr	Description	Direction
1	GND	GND
2	GND	GND
3	IN_RIGHT_N	IN
4	OUT_RIGHT_P	OUT
5	IN_RIGHT_P	IN
6	OUT_RIGHT_N	OUT
7	GND	GND
8	GND	GND
9	IN_LEFT_N	IN
10	OUT_LEFT_P	OUT
11	IN_LEFT_P	IN
12	OUT_LEFT_N	OUT
13	AUX_DAC	I/O
14	GND	GND



## Evaluation kit for Multimedia Bluetooth™ Modules Datasheet

### 3.7 Host Controlled Interface (HCI)

The module can be controlled by an external host processor via the Host Controlled Interface. The host processor is then running the Bluetooth stack and is communication over the USB interface. You will have to change the firmware on the module to a “HCI firmware” to be able to use an external host processor. Setting switch SW2 in the HCI-position described in the image below enables the HCI interface. Please look at the specific datasheet for the module for more information about the HCI firmware.

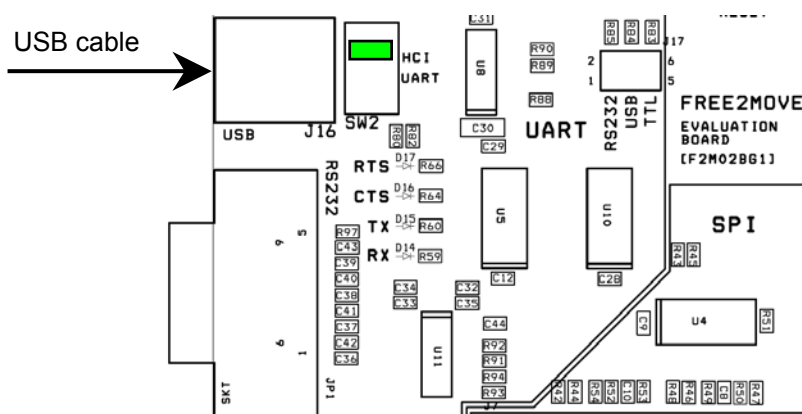

**Important note:** The evaluation board has a hardware error making it impossible to power the module when switch SW2 is in the “HCI” position. The error occurs because the USB-to-UART transceiver will put the voltage regulators powering the module to an “idle”-state. The only simple solution to this is to cut the stripe line going from resistor R90 to pin 12 on the IC U8 (FTDI). Please look at the image below for information on which stripe line to cut. The evaluation board will have exactly the same behavior without the stripe line and can be used with all other firmware versions.

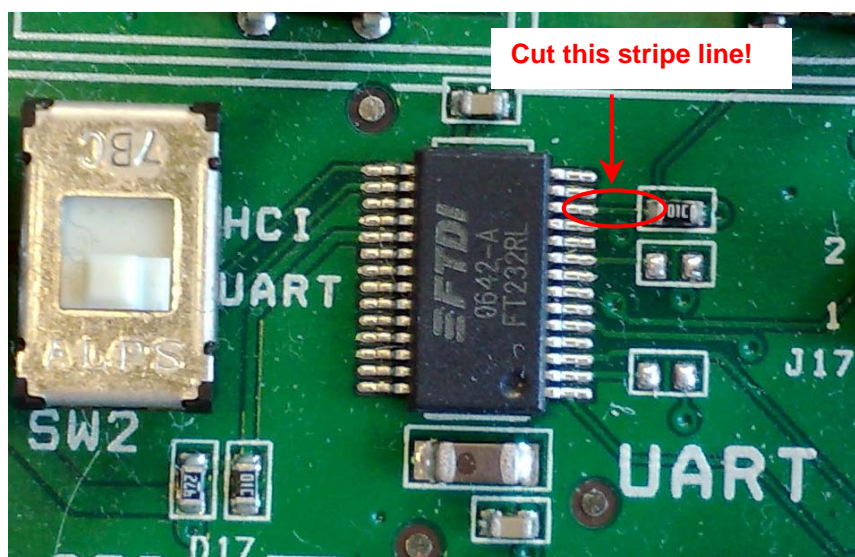

**Note:** The Host Bluetooth Stack is not provided from Free2move!



# Evaluation kit for Multimedia Bluetooth™ Modules

## Datasheet

### 4 Layout

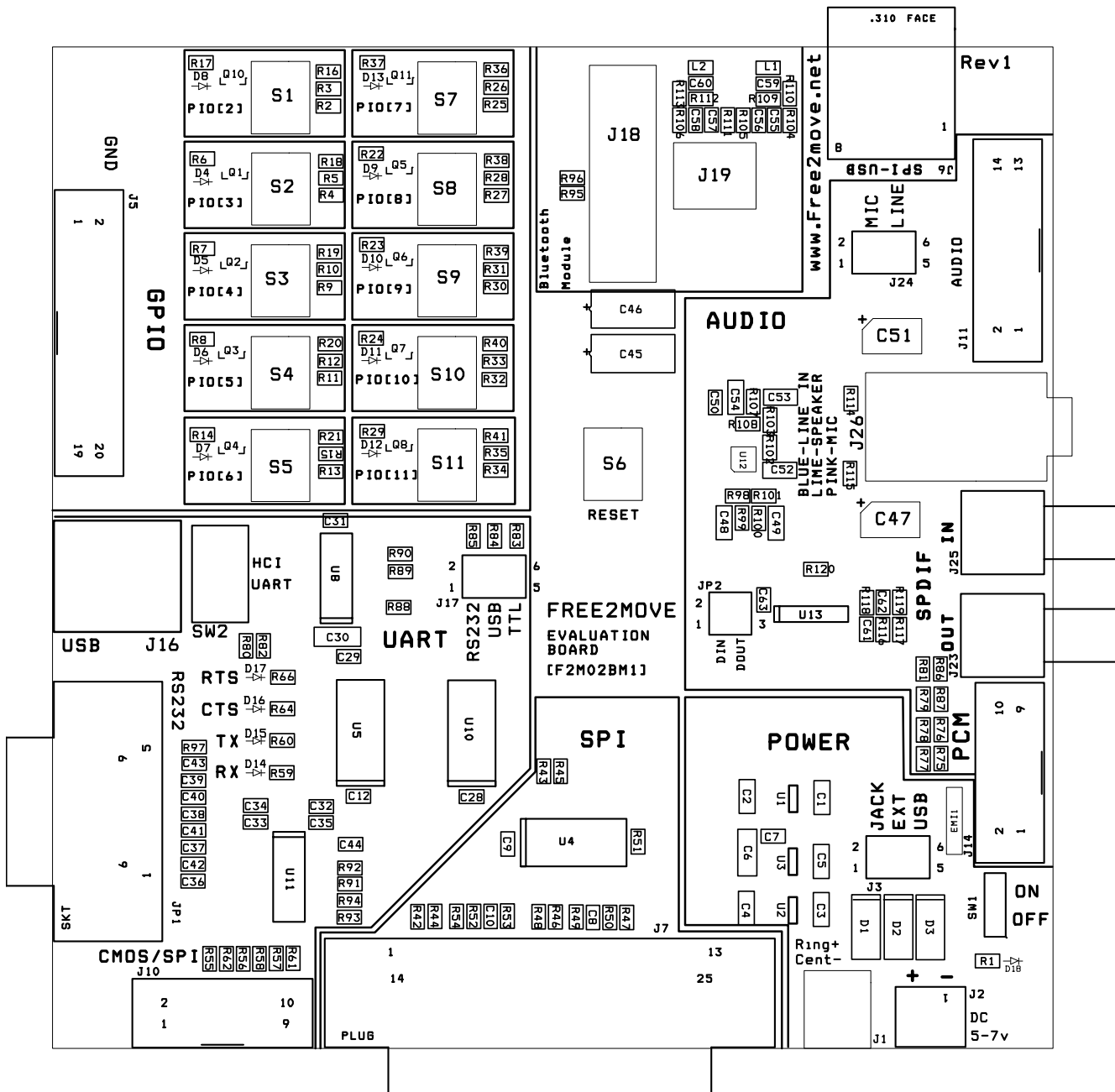





## Evaluation kit for Multimedia Bluetooth™ Modules Datasheet

### 6 Bill of materials

Quantity	Circuit Reference	Description	Value	Tolerance	Voltage	Package	Manuf.	Manuf No.
1	1000 78 01	PCB	1,6mm			120x120mm		
	C1,2,3,4,5,48,49,52,5 103, 54	Ceramic capacitor	1u	Y5V	16V	0805		
	C7,9,10,12,28,29,31,3 142, 33,34,35,44,50,63	Ceramic capacitor	100n	X7R	16V	0603		
	1C6	Ceramic capacitor	10u	Y5V	10V	1206		
	1C8	Ceramic capacitor	100p	COG	16V	0603		
	2C61,62	Ceramic capacitor	10n	X7R	16V	0603		
	1C30	Ceramic capacitor	4u7	Y5V	10V	1206		
	C36,37,38,39,40,41,4 NM2, 43	Ceramic capacitor	22p	COG	16V	0603		
	4C55,56,57,58	Ceramic capacitor	47n	X7R	16V	0603		
	2C59,60	Ceramic capacitor	15p	COG	16V	0603		
	4C45,46,47,51	Tantalum capacitor	220u		4V	7343		
	3D1,2,3	Diod						10BQ030
	D4,5,6,7,8,9,10,11,12, 14 13,14,15,16,17	Yellow led				0603	Everlight	EL19-21UYC
	1D18	Green led				0603	Everlight	EL19-21SYGC
	1EMI1	EMI filter					murata	NFM61R30T472
	1JP1	DSUB-9 Female						44-068-15
	1JP2	Pin terminal 2x2				2,54mm	AMP	0-0826632-2
	1J1	Power connector					KYCON	KLDX-SMT-0201L-B
	1J2	Terminal block					Phoenix	MKDS 1/2-3,81
	3J3,17,24	Pin terminal 2x3				2,54mm	AMP	0-0826632-3
	1J5	Connector 2x10				2,54mm		43-155-37
	NMJ6	RJ45-connector					AMP	555153-1
	1J7	DSUB-25 Male						44-067-65
	2J10,14	Connector 2x5				2,54mm		43-155-03
	1J11	Connector 2x7				2,54mm		43-155-11
	1J12	Pin terminal				1 pole	TYP:	43-702-19
	1J16	USB-B port					AMP	292304-1
	1J18	Socket con. 2x20				1,27mm	GradConn	
	1J19	Socket con. 2x7				1,27mm	GradConn	BB02-CR142-K05-000000
	2J23,25	RCA JACK					KYCON	KLPX-0848A-2-O
	1J26	Audio Jack					KYCON	STX-4335-5BGP-S1
	2L1,2	RF Inductor	15n	+/-2%		0603	Murata	LQP18MN15NG02
	Q1,2,3,4,5,6,7,8,10,1 101	Transistor				SOT23		BC817-16
	R1,6,7,8,14,17,22,23, 1524,29,37,59,60,64,66	Thick film resistor	180			0603		
	R2,3,4,5,9,10,11,12,1 3,15, 25,26,27,28,30,31,32, 33,34,35,42,45,47,48, 51,54,82,83,84,85,90, 3394,120	Thick film resistor	10k			0603		
	R44,46,49,50,55,56,5 7, 58,77,78,79,81,116,1 14 18	Thick film resistor	100			0603		
	3R43,104,111	Thick film resistor	100k			0603		



## Evaluation kit for Multimedia Bluetooth™ Modules Datasheet

2R52,53	Thick film resistor	1k		0603	
R16,18,19,20,21,36,3 108,39,40,41	Thick film resistor	220k		0603	
2R95,96	Thick film resistor	27		0603	
6R75,76,86,87,109,112	Thick film resistor	2k2		0603	
1R80	Thick film resistor	4k7		0603	
NMR88,89,91,92,93,97	Thick film resistor			0603	
R98,99,100,101,102,1 803, 107,108	Thick film resistor	20k		0603	
2R105,106	Thick film resistor	150k		0603	
2R110,113	Thick film resistor	1M		0603	
2R114,115	Thick film resistor	3k3		0603	
2R117,119	Thick film resistor	75		0603	
1SW1	Power Switch			EAO	09.03290.01
1SW2	Switch			ALPS	SSSS922000
S1,2,3,4,5,6,7,8,9,10, 11 11	Button			ALPS	SKHHBV
2U1,2	Voltage regulator		SOT23-5	Torex	XC6209B332MR
1U3	Voltage regulator		SOT23-5	Texas	TPS73633DBVT
2U4,5	buffer/line driver		SO20		74HC541
1U8	USB-rs232tran.		SSOP28	FTDI	FT232RL
1U10	buffer/line driver		S020		74HC244
1U11	rs232-tranceiver		SSOP28	Maxim	MAX3237CAI/EAI
1U12	Diff-to-linear conv.		MSOP10	Texas	TPA6112A2DGQ
1U13	Hex inverter		SO14		74HC04





## Evaluation kit for Multimedia Bluetooth™ Modules Datasheet

---

### 7 Ordering information

#### Evaluation kit (without OEM-board!)

Part nr.	Description
F2M03M-KIT-1	Single Evaluation kit for Multimedia Bluetooth modules

#### Bare OEM-boards

Part nr.	Description
F2M02MLA-S03	OEM-board with F2M03MLA Bluetooth module, Wireless Audio Headset firmware

#### OEM-boards with additional pin sockets

Part nr.	Description
F2M02MLA-S03-K	OEM-board with F2M03MLA, Wireless Audio Headset, 14 and 40pin sockets

Please visit our website: [www.free2move.net](http://www.free2move.net) for more information about local distributors and dealers.



## Evaluation kit for Multimedia Bluetooth™ Modules Datasheet

---

### 8 Document history

Date	Revision	Reason for Change
MAY 2008	b	Added information about hardware problem when using modules with HCI-firmware
OCT 2007	a	Original Publication of this document.

## F2M03M-KIT Datasheet

Datasheet\_F2M03M-KIT\_rev\_b.pdf

**Last revision change**  
May 2008



## Evaluation kit for Multimedia Bluetooth™ Modules Datasheet

### Acronyms and definitions

Term:	Definition:
Bluetooth	A set of technologies providing audio and data transfer over short-range radio
ACL	Asynchronous Connection-Less. A Bluetooth data packet.
AC	Alternating Current
A-law	Audio encoding standard
API	Application Programming Interface
BCSP	BlueCore™ Serial Protocol
BER	Bit Error Rate. Used to measure the quality of a link
C/I	Carrier Over Interferer
CMOS	Complementary Metal Oxide Semiconductor
CODEC	Coder Decoder
CPU	Central Processing Unit
CQDDR	Channel Quality Driven Data Rate
CTS	Clear to Send
CVSD	Continuous Variable Slope Delta Modulation
DAC	Digital to Analogue Converter
dBm	Decibels relative to 1mW
DC	Direct Current
DFU	Device Firmware Upgrade
GCI	General Circuit Interface. Standard synchronous 2B+D ISDN timing interface
HCI	Host Controller Interface
Host	Application's microcontroller
Host Controller	Bluetooth integrated chip
HV	Header Value
ISDN	Integrated Services Digital Network
ISM	Industrial, Scientific and Medical
ksamples/s	kilosamples per second
L2CAP	Logical Link Control and Adaptation Protocol (protocol layer)
LC	Link Controller
LSB	Least-Significant Bit
p-law	Encoding standard
MISO	Master In Serial Out
OHCI	Open Host Controller Interface
PA	Power Amplifier
PCB	Printed Circuit Board
PCM	Pulse Code Modulation. Refers to digital voice data
PIO	Parallel Input Output
RAM	Random Access Memory
RF	Radio Frequency
RFCOMM	Protocol layer providing serial port emulation over L2CAP
RISC	Reduced Instruction Set Computer
RSSI	Receive Signal Strength Indication
RTS	Ready To Send
RX	Receive or Receiver
SCO	Synchronous Connection-Oriented. Voice oriented Bluetooth packet
SDP	Service Discovery Protocol
SIG	Special Interest Group
SPI	Serial Peripheral Interface
SPP	Serial Port Profile
TBD	To Be Defined
TX	Transmit or Transmitter
UART	Universal Asynchronous Receiver Transmitter
USB	Universal Serial Bus or Upper Side Band (depending on context)
VM	Virtual Machine
www	world wide web



## Evaluation kit for Multimedia Bluetooth™ Modules Datasheet

---

### Contact information

For support questions please contact your local dealer

For other purposes use: [info@free2move.net](mailto:info@free2move.net)

Website: [www.free2move.net](http://www.free2move.net)

Local dealer/distributor

A large dashed rectangular box intended for the user to provide the name and contact information of their local dealer or distributor.

The information given herein includes text, drawings, illustrations and schematics that are believed to be reliable. However, Free2move makes no warranties as to its accuracy or completeness and disclaims any liability in connection with its use. Free2move will in no case be liable for any incidental, indirect or consequential damages arising out of sale, resale, use or misuse of the product. Users of Free2move products should make their own evaluation to determine the suitability of each such product for the specific application.