



Grayhill, Inc.

## 62S11-L5-050CH

Dio brojeva:

62S11-L5-050CH

Proizvođač / robna marka:

Grayhill, Inc.

Opis proizvoda

ROTARY ENCODER OPTICAL 32PPR

Liste podataka:

 62S11-L5-050CH.pdf

Status RoHS

 Ne sadrži olovo / RoHS sukladnost

Stanje zaliha

2186 pcs stock

Brod od

Hong Kong

Put pošiljke

DHL/Fedex/TNT/UPS/EMS

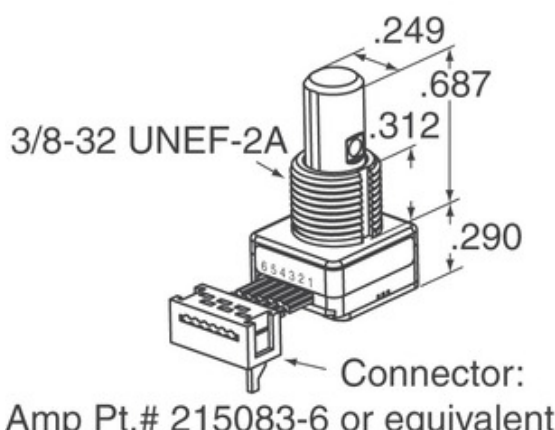

Slika može biti reprezentativna. Pogledajte specifikacije za pojedinosti o proizvodu.



### Specifikacije 62S11-L5-050CH

DIO BROJEVA	62S11-L5-050CH
PROIZVOĐAČ	Grayhill, Inc.
OPIS	ROTARY ENCODER OPTICAL 32PPR
STATUS SLOBODNOG OLOVA / ROHS-A	Ne sadrži olovo / RoHS sukladnost
RASPOLOŽIVA KOLIČINA	2186 pcs
OBRAZAC PODATAKA	 62S11-L5-050CH.pdf
NAPAJANJE	5V
STIL ZAVRŠETKA	Cable with Connector
NIZ	62S
ROTACIJSKI ŽIVOT (CIKLUSI MIN)	1M
PULSE PO REVOLUCIJI	32
VRSTA IZLAZA	Quadrature (Incremental)
DRUGA IMENA	62S11L5050CH
ORIJENTACIJA	Vertical
VRSTA MONTAŽE	Panel Mount
RAZINA OSJETLJIVOSTI VLAGE (MSL)	1 (Unlimited)
STATUS SLOBODNOG OLOVA / ROHS-A	Lead free / RoHS Compliant
VRSTA DAVAČA	Optical
ZAPONSKA	Yes
UGRAĐENI PREKIDAČ	Yes
VRSTA POGONA	1/4" Dia Flatted End

### Povezane oznake

Grayhill, Inc. 62S11-L5-050CH	Distributer 62S11-L5-050CH	Dobavljač 62S11-L5-050CH
Cijena 62S11-L5-050CH	Slike 62S11-L5-050CH	Slika 62S11-L5-050CH
62S11-L5-050CH PDF Datasheet	62S11-L5-050CH Preuzmite podatkovni list	62S11-L5-050CH Datasheet
Stock 62S11-L5-050CH	Kupi 62S11-L5-050CH	Kupi Grayhill, Inc. 62S11-L5-050CH
Grayhill, Inc. 62S11-L5-050CH	Dobavljač Grayhill, Inc.	Grayhill, Inc. Distributer
Grayhill, Inc. 62S11-L5-050CH	Grayhill Inc. 62S11-L5-050CH	

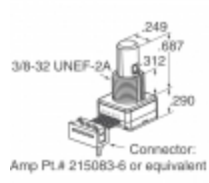
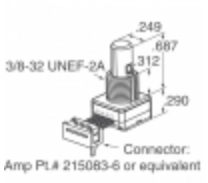
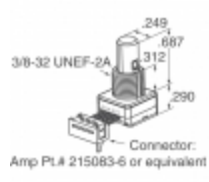
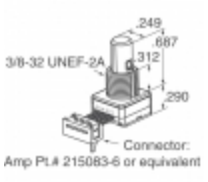
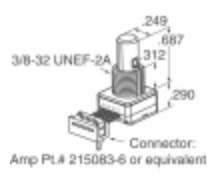
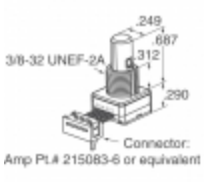
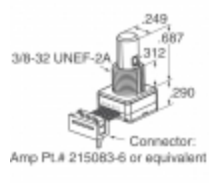
### Povezani proizvodi

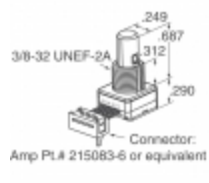
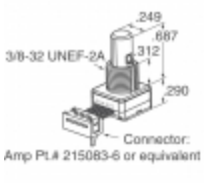
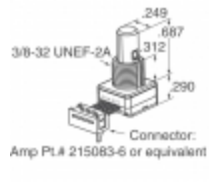
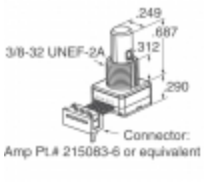
 <p><b>62S11-L5-020C</b> Proizvođači: Grayhill, Inc. Opis: ROTARY ENCODER OPTICAL 32PPR Na lageru: 2095 pcs</p> <p><b>RFQ</b></p>	 <p><b>62S11-L5-P</b> Proizvođači: Grayhill, Inc. Opis: ROTARY ENCODER OPTICAL 32PPR Na lageru: 2265 pcs</p> <p><b>RFQ</b></p>
 <p><b>62S11-L5-035C</b> Proizvođači: Grayhill, Inc. Opis: ROTARY ENCODER OPTICAL 32PPR Na lageru: 1861 pcs</p> <p><b>RFQ</b></p>	 <p><b>62S11-L9-020S</b> Proizvođači: Grayhill, Inc. Opis: ROTARY ENCODER OPTICAL 32PPR Na lageru: 2134 pcs</p> <p><b>RFQ</b></p>
 <p><b>62S11-L5-060C</b> Proizvođači: Grayhill, Inc. Opis: ROTARY ENCODER OPTICAL 32PPR Na lageru: 2163 pcs</p> <p><b>RFQ</b></p>	 <p><b>62S11-L5-030S</b> Proizvođači: Grayhill, Inc. Opis: ROTARY ENCODER OPTICAL 32PPR Na lageru: 2248 pcs</p> <p><b>RFQ</b></p>
 <p><b>62S11-L9-020CH</b> Proizvođači: Grayhill, Inc. Opis: ROTARY ENCODER OPTICAL 32PPR Na lageru: 2264 pcs</p> <p><b>RFQ</b></p>	 <p><b>62S11-L5-PH</b> Proizvođači: Grayhill, Inc. Opis: ROTARY ENCODER OPTICAL 32PPR Na lageru: 2218 pcs</p> <p><b>RFQ</b></p>
 <p><b>62S11-L5-020CH</b> Proizvođači: Grayhill, Inc. Opis: ROTARY ENCODER OPTICAL 32PPR Na lageru: 1861 pcs</p> <p><b>RFQ</b></p>	 <p><b>62S11-L4-PH</b> Proizvođači: Grayhill, Inc. Opis: ROTARY ENCODER OPTICAL 32PPR Na lageru: 2261 pcs</p> <p><b>RFQ</b></p>
 <p><b>62S11-L5-040C</b> Proizvođači: Grayhill, Inc. Opis: ROTARY ENCODER OPTICAL 32PPR Na lageru: 1990 pcs</p> <p><b>RFQ</b></p>	 <p><b>62S11-L9-020C</b> Proizvođači: Grayhill, Inc. Opis: ROTARY ENCODER OPTICAL 32PPR Na lageru: 1773 pcs</p> <p><b>RFQ</b></p>

Copyright © 2020 Pouzdan distributer elektroničkih komponenti

E-mail: [Info@infinity-electronic.com](mailto:Info@infinity-electronic.com)

Adresa: 17F, poslovna zgrada Gaylord, 114-118 Lockhart Road, Wan Chai, Hong Kong

