

Overview

The KEMET MIL-PRF-32535 X7R surface mount capacitors are designed, tested and screened to meet demanding high reliability defense and aerospace applications. MIL-PRF-32535 is Defense Logistics Agency's (DLA) first capacitor specification for defense and aerospace that capitalizes on industry leading base metal electrode (BME) technology. Qualified under performance specification, MIL-PRF-32535 and QPL listed, this series meets or exceeds the requirements outlined by DLA and is currently available in M (standard reliability) and T (high reliability) product levels. Driven by the demand for higher capacitance and smaller case size MLCCs in high reliability applications, KEMET's MIL-PRF-32535 X7R provides over an 55-fold increase in capacitance over MIL-PRF-55681 and MIL-PRF-123, allowing for reduced board space and continuing the trend for miniaturization.

In addition to being the first BME X7R dielectric qualified for use in defense and aerospace applications, MIL-PRF-32535 is the first DLA specification to recognize a flexible termination option. KEMET's flexible termination utilizes a pliable and conductive silver epoxy between the base metal and nickel barrier layers of the termination system. The addition of this epoxy layer inhibits the transfer of board stress to the rigid ceramic body, therefore mitigating flex cracks, which can result in a low IR or short circuit failures.

Benefits

- Patented BME technology
- Qualified per MIL-PRF-32535 (QPL)
- Standard reliability (M Level)
- High reliability (T Level)
- Flexible termination option available
- EIA 0402, 0603, 0805, 1206, 1210, 1812, 2220 case sizes
- DC voltage ratings of 4 V, 6.3 V, 10 V, 16 V, 25 V, and 50 V
- Capacitance offerings ranging from 39 pF up to 10 uF
- Available capacitance tolerances of $\pm 10\%$ and 20%
- Non-polar device, minimizing installation concerns

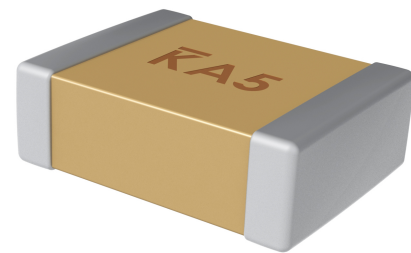

Applications

- Decoupling
- Bypass
- Filtering
- Transient voltage suppression

MIL-PRF-32535 Ordering Information

M32535	04	E2	Z	103	K	Z	M	B
MIL Prefix	Slash Sheet	Characteristic/Dielectric	Rated Voltage (VDC)	Capacitance Code (pF)	Capacitance Tolerance	Termination ^{1, 2, 3}	Product Level	Electrode
	02 = 0402 03 = 0603 04 = 0805 05 = 1206 06 = 1210 07 = 1812 08 = 2220	E2 = X7R	V = 4 W = 6.3 X = 10 Y = 16 Z = 25 A = 50	Two significant digits and number of zeros.	K = $\pm 10\%$ M = $\pm 20\%$	D = Sn/Pb solder dipped G = Nickel gold-plating R = Flexible termination with solder plating V = Flexible termination with nickel gold-plating Z = Sn/Pb solder plated	M = M Level T = T Level	B = BME

¹ Termination options D, R, and V are not available in EIA 0402 case size.

² Termination option D is not available in EIA 0603 case size.

³ Termination options D, G, and Z are not available in EIA 1812 case size.

KEMET Part Number Equivalent (For Reference Only)

(Do not use this ordering code if a QPL MIL-SPEC part type is required. Please order using MIL-SPEC ordering code. Details regarding MIL-PRF-32535 QPL ordering information is outlined above.)

C	0805	K	104	J	3	G	M	L	-
Ceramic	Case Size (L" x W")	Specification/Series	Capacitance Code (pF)	Capacitance Tolerance ²	Rated Voltage (VDC)	Dielectric	Failure Rate/Design	Termination Finish	Packaging/Grade (C-Spec)
	0402 0603 0805 1206 1210 1812 2220	K = MIL-PRF-32535	Two significant digits and number of zeros.	K = $\pm 10\%$ M = $\pm 20\%$	7 = 4 9 = 6.3 8 = 10 4 = 16 3 = 25 5 = 50	R = X7R	M = M Level standard termination N = M Level flexible termination T = T Level standard termination V = T Level flexible termination	L = Sn/Pb solder plated H = Sn/Pb solder dipped G = Nickel gold-plating	See "Packaging C-Spec Ordering Options Table"

Packaging C-Spec Ordering Options Table

Packaging Type ¹	Packaging/Grade Ordering Code (C-Spec)
Standard Packaging (Waffle Tray)	Not required (blank)
7" Tape & Reel	Contact Sales

¹ Default packaging with no C-Spec is "Waffle Tray," and is recommended for order quantities of less than 250 pieces. See Waffle Tray packaging information section for additional details.

¹ See Tape & Reel Packaging information section of the datasheet for additional details.

Dimensions per MIL-PRF-32535 – Inches (Millimeters)

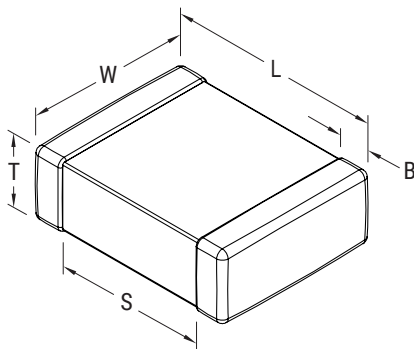

EIA Size Code	Metric Size Code	L Length	W Width	T Thickness	B Bandwidth	Maximum Part Weight (mg) ³	Mounting Technique
0402	1005	0.040 ±0.004 (1.02 ±0.10)	0.020 ±0.004 (0.51 ±0.10)	0.024 (0.61)	0.004 (0.100) minimum	1.6	Solder reflow only
0603	1608	0.063 ±0.006 (1.60 ±0.15)	0.032 ±0.006 (0.81 ±0.15)	0.039 (0.99)	0.016 ±0.008 (0.41 ±0.20)	6.3	Solder wave or solder reflow
0805 ¹	2012	0.079 ±0.010 (2.01 ±0.25)	0.050 ±0.010 (1.27 ±0.25)	0.060 (1.52)	0.020 ±0.010 (0.51 ±0.25)	20	
1206 ²	3216	0.126 ±0.010 (3.20 ±0.25)	0.063 ±0.010 (1.60 ±0.25)	0.070 (1.78)	0.020 ±0.014 (0.51 ±0.36)	57	
1210 ²	3225	0.126 ±0.010 (3.20 ±0.25)	0.098 ±0.010 (2.49 ±0.25)	0.110 (2.79)	0.020 ±0.014 (0.51 ±0.36)	108	Solder reflow only
1812 ²	4532	0.178 ±0.012 (4.52 ±0.30)	0.126 ±0.012 (3.20 ±0.30)	0.110 (2.79)	0.024 ±0.018 (0.61 ±0.46)	216	
2220 ²	5650	0.224 ±0.016 (5.69 ±0.41)	0.197 ±0.016 (5.00 ±0.41)	0.110 (2.79)	0.025 ±0.018 (0.64 ±0.46)	430	

¹ For EIA 0805 solder dipped termination finish, add 0.020 (0.51) to the positive length tolerance and 0.015 (0.38) to the positive width and thickness tolerance.

² For EIA 1206, 1210, 1812 and 2220 solder dipped termination finishes, add 0.025 (0.64) to the positive length tolerance and 0.015 (0.38) to the positive width and thickness tolerance.

³ Maximum Part Weight represents the maximum weight in the given case size for all voltages.

Environmental Compliance

These devices are RoHS compliant only if ordered with gold (Au) termination finish.

Electrical Parameters/Characteristics

Item	Parameters/Characteristics																								
Operating temperature range	-55°C to +125°C																								
Capacitance change with reference to +25°C and 0 VDC applied (TCC)	±15%																								
Aging rate (maximum % capacitance loss/decade hour)	3%																								
¹ Dielectric Withstanding Voltage (DWV)	250% of rated voltage (5 ±1 seconds and charge/discharge not exceeding 50 mA)																								
² Dissipation Factor (DF) maximum limit at 25°C	<table border="1"> <thead> <tr> <th colspan="6">Maximum Allowable DF (%)</th> </tr> <tr> <th colspan="6">Rated Voltage (VDC)</th> </tr> </thead> <tbody> <tr> <td>4</td> <td>6.3</td> <td>10</td> <td>16</td> <td>25</td> <td>≥ 50</td> </tr> <tr> <td>7.5</td> <td>7.5</td> <td>5.0</td> <td>3.5</td> <td>3.5</td> <td>2.5</td> </tr> </tbody> </table>	Maximum Allowable DF (%)						Rated Voltage (VDC)						4	6.3	10	16	25	≥ 50	7.5	7.5	5.0	3.5	3.5	2.5
Maximum Allowable DF (%)																									
Rated Voltage (VDC)																									
4	6.3	10	16	25	≥ 50																				
7.5	7.5	5.0	3.5	3.5	2.5																				
³ Insulation Resistance (IR) minimum limit at 25°C	Rated voltage < 25 V 500 MΩ μF or 100 GΩ, whichever is less Rated voltage ≥ 25 V 1,000 MΩ μF or 100 GΩ, whichever is less (Rated voltage applied for 120 seconds maximum at 25°C)																								

¹ DWV is the voltage a capacitor can withstand (survive) for a short period of time. It exceeds the nominal and continuous working voltage of the capacitor.

² Capacitance and dissipation factor (DF) measured under the following conditions:

1 MHz ±100 kHz and 1.0 V_{rms} ±0.2 V if capacitance ≤ 1,000 pF

1 kHz ±50 Hz and 1.0 V_{rms} ±0.2 V if capacitance > 1,000 pF

³ To obtain IR limit, divide MΩ-μF value by the capacitance and compare to GΩ limit. Select the lower of the two limits.

Capacitance and dissipation factor (DF) measured under the following conditions:

Note: When measuring capacitance it is important to ensure the set voltage level is held constant. The HP4284 and Agilent E4980 have a feature known as automatic level control (ALC). The ALC feature should be switched to "ON."

Table 1A – Capacitance Range/Selection Waterfall (0402 – 0805 Case Sizes)

Capacitance	Cap Code	Case Size		0402						0603						0805					
		Voltage Code (MIL)		V	W	X	Y	Z	A	V	W	X	Y	Z	A	V	W	X	Y	Z	A
		Voltage Code (KEMET)		7	9	8	4	3	5	7	9	8	4	3	5	7	9	8	4	3	5
		Rated Voltage (VDC)		4	6.3	10	16	25	50	4	6.3	10	16	25	50	4	6.3	10	16	25	50
		Capacitance Tolerance		Product Availability																	
39 pF	390	K	M	•	•	•	•	•	•												
47 pF	470	K	M	•	•	•	•	•	•												
56 pF	560	K	M	•	•	•	•	•	•												
68 pF	680	K	M	•	•	•	•	•	•												
82 pF	820	K	M	•	•	•	•	•	•												
100 pF	101	K	M	•	•	•	•	•	•												
120 pF	121	K	M	•	•	•	•	•	•												
150 pF	151	K	M	•	•	•	•	•	•												
180 pF	181	K	M	•	•	•	•	•	•												
220 pF	221	K	M	•	•	•	•	•	•												
270 pF	271	K	M	•	•	•	•	•	•												
330 pF	331	K	M	•	•	•	•	•	•												
390 pF	391	K	M	•	•	•	•	•	•												
470 pF	471	K	M	•	•	•	•	•	•												
560 pF	561	K	M	•	•	•	•	•	•												
680 pF	681	K	M	•	•	•	•	•	•												
820 pF	821	K	M	•	•	•	•	•	•												
1000 pF	102	K	M	•	•	•	•	•	•	•	•	•	•	•	•	•	•	•	•	•	•
1200 pF	122	K	M	•	•	•	•	•	•	•	•	•	•	•	•	•	•	•	•	•	•
1500 pF	152	K	M	•	•	•	•	•	•	•	•	•	•	•	•	•	•	•	•	•	•
1800 pF	182	K	M	•	•	•	•	•	•	•	•	•	•	•	•	•	•	•	•	•	•
2200 pF	222	K	M	•	•	•	•	•	•	•	•	•	•	•	•	•	•	•	•	•	•
2700 pF	272	K	M	•	•	•	•	•	•	•	•	•	•	•	•	•	•	•	•	•	•
3300 pF	332	K	M	•	•	•	•	•	•	•	•	•	•	•	•	•	•	•	•	•	•
3900 pF	392	K	M	•	•	•	•	•	•	•	•	•	•	•	•	•	•	•	•	•	•
4700 pF	472	K	M	•	•	•	•	•	•	•	•	•	•	•	•	•	•	•	•	•	•
5600 pF	562	K	M	•	•	•	•	•	•	•	•	•	•	•	•	•	•	•	•	•	•
6800 pF	682	K	M	•	•	•	•	•	•	•	•	•	•	•	•	•	•	•	•	•	•
8200 pF	822	K	M	•	•	•	•	•	•	•	•	•	•	•	•	•	•	•	•	•	•
10000 pF	103	K	M	•	•	•	•	•	•	•	•	•	•	•	•	•	•	•	•	•	•
12000 pF	123	K	M	•	•	•	•	•	•	•	•	•	•	•	•	•	•	•	•	•	•
15000 pF	153	K	M	•	•	•	•	•	•	•	•	•	•	•	•	•	•	•	•	•	•
18000 pF	183	K	M	•	•	•	•	•	•	•	•	•	•	•	•	•	•	•	•	•	•
22000 pF	223	K	M	•	•	•	•	•	•	•	•	•	•	•	•	•	•	•	•	•	•
27000 pF	273	K	M	•	•	•	•	•	•	•	•	•	•	•	•	•	•	•	•	•	•
33000 pF	333	K	M	•	•	•	•	•	•	•	•	•	•	•	•	•	•	•	•	•	•
39000 pF	393	K	M	•	•	•	•	•	•	•	•	•	•	•	•	•	•	•	•	•	•
47000 pF	473	K	M	•	•	•	•	•	•	•	•	•	•	•	•	•	•	•	•	•	•
51000 pF	513	K	M	•	•	•	•	•	•	•	•	•	•	•	•	•	•	•	•	•	•
56000 pF	563	K	M	•	•	•	•	•	•	•	•	•	•	•	•	•	•	•	•	•	•
68000 pF	683	K	M	•	•	•	•	•	•	•	•	•	•	•	•	•	•	•	•	•	•
82000 pF	823	K	M	•	•	•	•	•	•	•	•	•	•	•	•	•	•	•	•	•	•
100000 pF	104	K	M	•	•	•	•	•	•	•	•	•	•	•	•	•	•	•	•	•	•
120000 pF	124	K	M	•	•	•	•	•	•	•	•	•	•	•	•	•	•	•	•	•	•
150000 pF	154	K	M	•	•	•	•	•	•	•	•	•	•	•	•	•	•	•	•	•	•
180000 pF	184	K	M	•	•	•	•	•	•	•	•	•	•	•	•	•	•	•	•	•	•
220000 pF	224	K	M	•	•	•	•	•	•	•	•	•	•	•	•	•	•	•	•	•	•
270000 pF	274	K	M	•	•	•	•	•	•	•	•	•	•	•	•	•	•	•	•	•	•
330000 pF	334	K	M	•	•	•	•	•	•	•	•	•	•	•	•	•	•	•	•	•	•
390000 pF	394	K	M	•	•	•	•	•	•	•	•	•	•	•	•	•	•	•	•	•	•
470000 pF	474	K	M	•	•	•	•	•	•	•	•	•	•	•	•	•	•	•	•	•	•
560000 pF	564	K	M	•	•	•	•	•	•	•	•	•	•	•	•	•	•	•	•	•	•
680000 pF	684	K	M	•	•	•	•	•	•	•	•	•	•	•	•	•	•	•	•	•	•
820000 pF	824	K	M	•	•	•	•	•	•	•	•	•	•	•	•	•	•	•	•	•	•
1000000 pF	105	K	M	•	•	•	•	•	•	•	•	•	•	•	•	•	•	•	•	•	•
Capacitance	Cap Code	Rated Voltage		4	6.3	10	16	25	50	4	6.3	10	16	25	50	4	6.3	10	16	25	50
		Voltage Code		7	9	8	4	3	5	7	9	8	4	3	5	7	9	8	4	3	5
		Case Size		0402						0603						0805					

Table 1B – Capacitance Range/Selection Waterfall (1206 – 1210 Case Sizes)

Capacitance	Cap Code	Case Size		1206						1210					
		Voltage Code (MIL)		V	W	X	Y	Z	A	V	W	X	Y	Z	A
		Voltage Code (KEMET)		7	9	8	4	3	5	7	9	8	4	3	5
		Rated Voltage (VDC)		4	6.3	10	16	25	50	4	6.3	10	16	25	50
		Capacitance Tolerance		Product Availability											
82000 pF	823	K	M												
100000 pF	104	K	M	•	•	•	•	•	•	•	•	•	•	•	
120000 pF	124	K	M	•	•	•	•	•	•	•	•	•	•	•	
150000 pF	154	K	M	•	•	•	•	•	•	•	•	•	•	•	
180000 pF	184	K	M	•	•	•	•	•	•	•	•	•	•	•	
220000 pF	224	K	M	•	•	•	•	•	•	•	•	•	•	•	
270000 pF	274	K	M	•	•	•	•	•	•	•	•	•	•	•	
330000 pF	334	K	M	•	•	•	•	•	•	•	•	•	•	•	
390000 pF	394	K	M	•	•	•	•	•	•	•	•	•	•	•	
470000 pF	474	K	M	•	•	•	•	•	•	•	•	•	•	•	
560000 pF	564	K	M	•	•	•	•	•	•	•	•	•	•	•	
680000 pF	684	K	M	•	•	•	•	•	•	•	•	•	•	•	
820000 pF	824	K	M	•	•	•	•	•	•	•	•	•	•	•	
1000000 pF	105	K	M	•	•	•	•	•	•	•	•	•	•	•	
1200000 pF	125	K	M	•	•	•	•	•	•	•	•	•	•	•	
1500000 pF	155	K	M	•	•	•	•	•	•	•	•	•	•	•	
1800000 pF	185	K	M	•	•	•	•	•	•	•	•	•	•	•	
2200000 pF	225	K	M	•	•	•	•	•	•	•	•	•	•	•	
2700000 pF	275	K	M	•	•	•	•	•	•	•	•	•	•	•	
3300000 pF	335	K	M	•	•	•	•	•	•	•	•	•	•	•	
Capacitance	Cap Code	Rated Voltage		4	6.3	10	16	25	50	4	6.3	10	16	25	50
		Voltage Code		7	9	8	4	3	5	7	9	8	4	3	5
		Case Size		1206						1210					

Table 1C – Capacitance Range/Selection Waterfall (1812 – 2220 Case Sizes)

Capacitance	Cap Code	Case Size		1812						2220				
		Voltage Code (MIL)		V	W	X	Y	Z	A	V	W	X	Y	Z
		Voltage Code (KEMET)		7	9	8	4	3	5	7	9	8	4	3
		Rated Voltage (VDC)		4	6.3	10	16	25	50	4	6.3	10	16	25
Capacitance Tolerance		Product Availability												
100000 pF	104	K	M	•	•	•	•	•	•	•	•	•	•	•
120000 pF	124	K	M	•	•	•	•	•	•	•	•	•	•	•
150000 pF	154	K	M	•	•	•	•	•	•	•	•	•	•	•
180000 pF	184	K	M	•	•	•	•	•	•	•	•	•	•	•
220000 pF	224	K	M	•	•	•	•	•	•	•	•	•	•	•
270000 pF	274	K	M	•	•	•	•	•	•	•	•	•	•	•
330000 pF	334	K	M	•	•	•	•	•	•	•	•	•	•	•
390000 pF	394	K	M	•	•	•	•	•	•	•	•	•	•	•
470000 pF	474	K	M	•	•	•	•	•	•	•	•	•	•	•
560000 pF	564	K	M	•	•	•	•	•	•	•	•	•	•	•
680000 pF	684	K	M	•	•	•	•	•	•	•	•	•	•	•
820000 pF	824	K	M	•	•	•	•	•	•	•	•	•	•	•
1000000 pF	105	K	M	•	•	•	•	•	•	•	•	•	•	•
1200000 pF	125	K	M	•	•	•	•	•	•	•	•	•	•	•
1500000 pF	155	K	M	•	•	•	•	•	•	•	•	•	•	•
1800000 pF	185	K	M	•	•	•	•	•	•	•	•	•	•	•
2200000 pF	225	K	M	•	•	•	•	•	•	•	•	•	•	•
2700000 pF	275	K	M	•	•	•	•	•	•	•	•	•	•	•
3300000 pF	335	K	M	•	•	•	•	•	•	•	•	•	•	•
3900000 pF	395	K	M	•	•	•	•	•	•	•	•	•	•	•
4700000 pF	475	K	M	•	•	•	•	•	•	•	•	•	•	•
5600000 pF	565	K	M	•	•	•	•	•	•	•	•	•	•	•
6800000 pF	685	K	M	•	•	•	•	•	•	•	•	•	•	•
8200000 pF	825	K	M	•	•	•	•	•	•	•	•	•	•	•
10000000 pF	106	K	M	•	•	•	•	•	•	•	•	•	•	•
Capacitance	Cap Code	Rated Voltage		4	6.3	10	16	25	50	4	6.3	10	16	25
		Voltage Code		7	9	8	4	3	5	7	9	8	4	3
		Case Size		1812						2220				

Table 2 – Chip Capacitor Land Pattern Design Recommendations per IPC–7351

EIA Size Code	Metric Size Code	Density Level A: Maximum (Most) Land Protrusion (mm)					Density Level B: Median (Nominal) Land Protrusion (mm)					Density Level C: Minimum (Least) Land Protrusion (mm)				
		C	Y	X	V1	V2	C	Y	X	V1	V2	C	Y	X	V1	V2
0402	1005	0.50	0.72	0.72	2.20	1.20	0.45	0.62	0.62	1.90	1.00	0.40	0.52	0.52	1.60	0.80
0603	1608	0.90	1.15	1.10	4.00	2.10	0.80	0.95	1.00	3.10	1.50	0.60	0.75	0.90	2.40	1.20
0805	2012	1.00	1.35	1.55	4.40	2.60	0.90	1.15	1.45	3.50	2.00	0.75	0.95	1.35	2.80	1.70
1206	3216	1.60	1.35	1.90	5.60	2.90	1.50	1.15	1.80	4.70	2.30	1.40	0.95	1.70	4.00	2.00
1210	3225	1.60	1.35	2.80	5.65	3.80	1.50	1.15	2.70	4.70	3.20	1.40	0.95	2.60	4.00	2.90
1812	4532	2.15	1.60	3.60	6.90	4.60	2.05	1.40	3.50	6.00	4.00	1.95	1.20	3.40	5.30	3.70
2220	5650	2.75	1.70	5.50	8.20	6.50	2.65	1.50	5.40	7.30	5.90	2.55	1.30	5.30	6.60	5.60

Density Level A: For low-density product applications. It is recommended for wave solder applications and provides a wider process window for reflow solder processes. KEMET only recommends wave soldering of EIA 0603, 0805 and 1206 case sizes.

Density Level B: For products with a moderate level of component density. It provides a robust solder attachment condition for reflow solder processes.

Density Level C: For high component density product applications. Before adapting the minimum land pattern variations, the user should perform qualification testing based on the conditions outlined in IPC Standard 7351 (IPC-7351).

Image below based on Density Level B for an EIA 1210 case size.

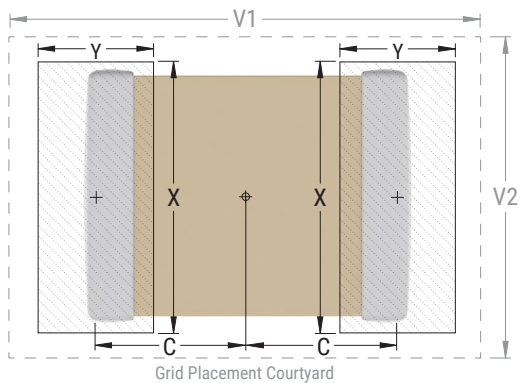

Soldering Process

Recommended Soldering Technique:

- Solder wave or solder reflow for EIA case sizes 0603, 0805 and 1206
- All other EIA case sizes are limited to solder reflow only

Recommended Reflow Soldering Profile:

KEMET's families of Surface Mount Multilayer Ceramic Capacitors (SMD MLCCs) are compatible with wave (single or dual), convection, IR, or vapor phase reflow techniques. Preheating of these components is recommended to avoid extreme thermal stress. KEMET's recommended profile conditions for convection and IR reflow reflect the profile conditions of the IPC/J-STD-020 standard for moisture sensitivity testing. These devices can safely withstand a maximum of three reflow passes at these conditions.

Profile Feature	Termination Finish
	SnPb
Preheat/Soak	
Temperature minimum (T_{Smin})	100°C
Temperature maximum (T_{Smax})	150°C
Time (t_s) from T_{Smin} to T_{Smax}	60 – 120 seconds
Ramp-up rate (T_L to T_p)	3°C/second maximum
Liquidous temperature (T_L)	183°C
Time above liquidous (t_L)	60 – 150 seconds
Peak temperature (T_p)	235°C
Time within 5°C of maximum peak temperature (t_p)	20 seconds maximum
Ramp-down rate (T_p to T_L)	6°C/second maximum
Time 25°C to peak temperature	6 minutes maximum

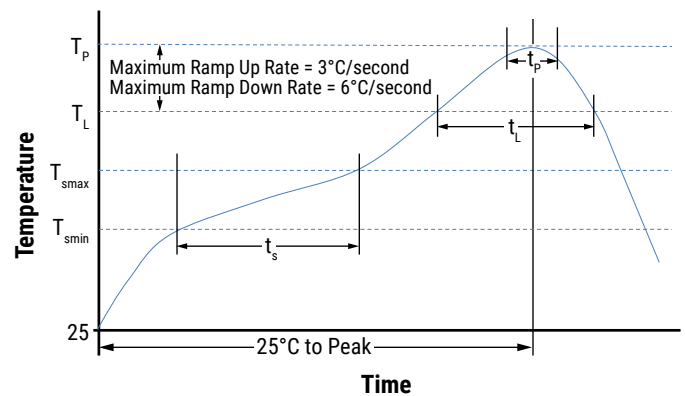

Note: All temperatures refer to the center of the package, measured on the capacitor body surface that is facing up during assembly reflow.

Table 3 – Performance & Reliability: Test Methods and Conditions

Inspection	Test Method	MIL-PRF-32535 M-Level	MIL-PRF-32535 T-Level
In-Process Inspection			
Nondestructive internal examination (pre-termination)	MIL-PRF-32535 Method 4.6.1	Not required	Yes (100%)
Visual examination (post-termination)	MIL-PRF-32535 Method 4.6.2	Not required	Yes (100%)
Group A Inspection			
Thermal shock	MIL-PRF-32535 Method 4.6.3	Not required	Yes (100%)
Nondestructive internal examination (case sizes ≥ 0805 only)	MIL-PRF-32535 Method 4.6.1	Not required	Yes (100%)
Voltage conditioning	MIL-PRF-32535 Method 4.6.3	Yes (100%)	Yes (100%)
Visual and mechanical inspection	MIL-PRF-32535 Method 4.6.2	Yes (per inspection lot)	Yes (production lot sample)
Destructive physical analysis (DPA)	MIL-PRF-32535 Method 4.6.8	Not required	Yes (production lot sample)
Solderability (solder dipped and solder plated terminations only)	MIL-PRF-32535 Method 4.6.11	Yes (per inspection lot)	Yes (production lot sample)
Wire bond strength (gold-plated terminations only)	MIL-PRF-32535 Method 4.6.12	Yes (per inspection lot)	Yes (production lot sample)
Group B Inspection			
Thermal shock	MIL-PRF-32535 Method 4.6.3	Yes (periodic)	Yes (production lot sample)
Life	MIL-PRF-32535 Method 4.6.16	Yes (periodic)	Yes (production lot sample)
Temperature humidity bias (load humidity)	MIL-PRF-32535 Method 4.6.15	Yes (periodic)	Yes (production lot sample)
Voltage - temperature limits/temperature characteristic	MIL-PRF-32535 Method 4.6.14	Yes (periodic)	Yes (production lot sample)
Dielectric breakdown voltage (UVBD)	MIL-PRF-32535 Method 4.6.17	Yes (periodic)	Yes (production lot sample)
Group C Inspection			
Board flex	MIL-PRF-32535 Method 4.6.9	Yes (periodic)	Yes (periodic)
Shear stress	MIL-PRF-32535 Method 4.6.10	Yes (periodic)	Yes (periodic)
Resistance to soldering heat	MIL-PRF-32535 Method 4.6.13	Yes (periodic)	Yes (periodic)

Storage and Handling

Ceramic chip capacitors should be stored in normal working environments. While the chips themselves are quite robust in other environments, solderability will be degraded by exposure to high temperatures, high humidity, corrosive atmospheres, and long term storage. In addition, packaging materials will be degraded by high temperature – reels may soften or warp and tape peel force may increase. KEMET recommends that maximum storage temperature not exceed 40°C and maximum storage humidity not exceed 70% relative humidity. In addition, temperature fluctuations should be minimized to avoid condensation on the parts. The atmospheres should be free of chlorine and sulfur bearing compounds. For optimized solderability chip stock should be used promptly, preferably within 1.5 years upon receipt.

Construction

Standard Termination

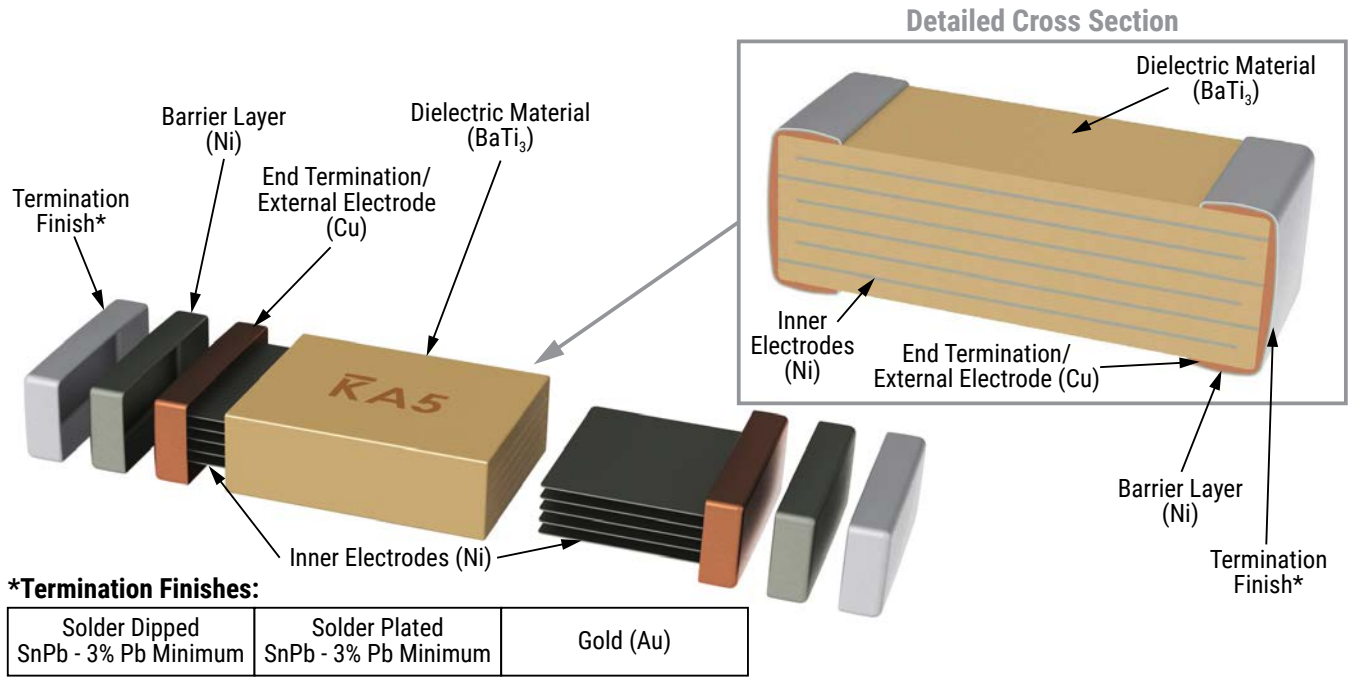

Flexible Termination

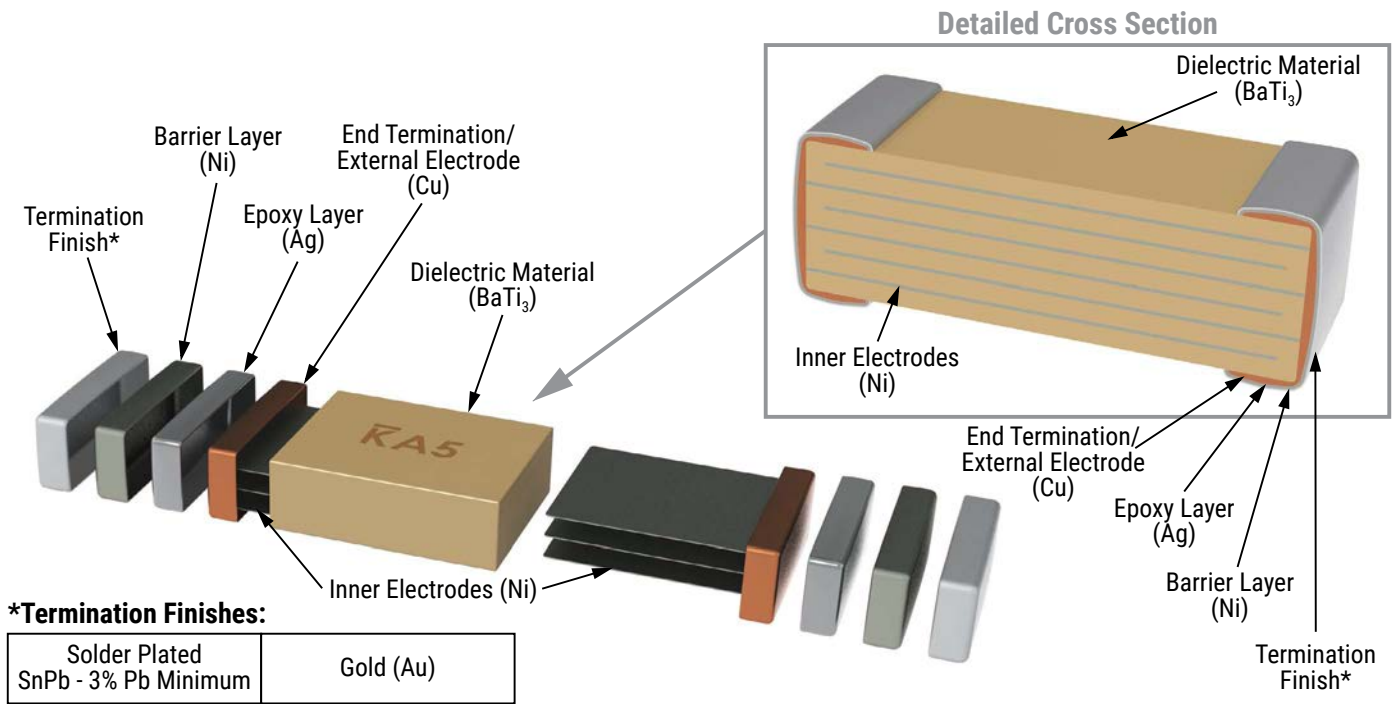

Capacitor Marking:

KEMET MIL-PRF-32535 ceramic capacitors will be marked in accordance with the military specification on case sizes ≥ 0805 . Case sizes below 0805 will not be marked. Two sides of the ceramic body will be laser marked with a “K” to identify KEMET, followed by two characters to identify the capacitance value.

The marking appears in legible contrast. Illustrated below is an example of an MLCC with laser the marking of “KA5”, which designates a KEMET device with the rated capacitance of 100 nF.

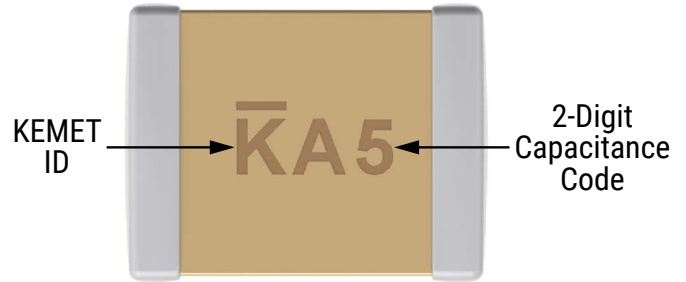

Capacitance (pF) For Various Alpha/Numeral Identifiers										
Alpha Character	Numeral									
	9	0	1	2	3	4	5	6	7	8
Capacitance (pF)										
A	0.1	1.0	10	100	1,000	10,000	100,000	1,000,000	10,000,000	100,000,000
B	0.11	1.1	11	110	1,100	11,000	110,000	1,100,000	11,000,000	110,000,000
C	0.12	1.2	12	120	1,200	12,000	120,000	1,200,000	12,000,000	120,000,000
D	0.13	1.3	13	130	1,300	13,000	130,000	1,300,000	13,000,000	130,000,000
E	0.15	1.5	15	150	1,500	15,000	150,000	1,500,000	15,000,000	150,000,000
F	0.16	1.6	16	160	1,600	16,000	160,000	1,600,000	16,000,000	160,000,000
G	0.18	1.8	18	180	1,800	18,000	180,000	1,800,000	18,000,000	180,000,000
H	0.2	2.0	20	200	2,000	20,000	200,000	2,000,000	20,000,000	200,000,000
J	0.22	2.2	22	220	2,200	22,000	220,000	2,200,000	22,000,000	220,000,000
K	0.24	2.4	24	240	2,400	24,000	240,000	2,400,000	24,000,000	240,000,000
L	0.27	2.7	27	270	2,700	27,000	270,000	2,700,000	27,000,000	270,000,000
M	0.3	3.0	30	300	3,000	30,000	300,000	3,000,000	30,000,000	300,000,000
N	0.33	3.3	33	330	3,300	33,000	330,000	3,300,000	33,000,000	330,000,000
P	0.36	3.6	36	360	3,600	36,000	360,000	3,600,000	36,000,000	360,000,000
Q	0.39	3.9	39	390	3,900	39,000	390,000	3,900,000	39,000,000	390,000,000
R	0.43	4.3	43	430	4,300	43,000	430,000	4,300,000	43,000,000	430,000,000
S	0.47	4.7	47	470	4,700	47,000	470,000	4,700,000	47,000,000	470,000,000
T	0.51	5.1	51	510	5,100	51,000	510,000	5,100,000	51,000,000	510,000,000
U	0.56	5.6	56	560	5,600	56,000	560,000	5,600,000	56,000,000	560,000,000
V	0.62	6.2	62	620	6,200	62,000	620,000	6,200,000	62,000,000	620,000,000
W	0.68	6.8	68	680	6,800	68,000	680,000	6,800,000	68,000,000	680,000,000
X	0.75	7.5	75	750	7,500	75,000	750,000	7,500,000	75,000,000	750,000,000
Y	0.82	8.2	82	820	8,200	82,000	820,000	8,200,000	82,000,000	820,000,000
Z	0.91	9.1	91	910	9,100	91,000	910,000	9,100,000	91,000,000	910,000,000
a	0.25	2.5	25	250	2,500	25,000	250,000	2,500,000	25,000,000	250,000,000
b	0.35	3.5	35	350	3,500	35,000	350,000	3,500,000	35,000,000	350,000,000
d	0.4	4.0	40	400	4,000	40,000	400,000	4,000,000	40,000,000	400,000,000
e	0.45	4.5	45	450	4,500	45,000	450,000	4,500,000	45,000,000	450,000,000
f	0.5	5.0	50	500	5,000	50,000	500,000	5,000,000	50,000,000	500,000,000
m	0.6	6.0	60	600	6,000	60,000	600,000	6,000,000	60,000,000	600,000,000
n	0.7	7.0	70	700	7,000	70,000	700,000	7,000,000	70,000,000	700,000,000
t	0.8	8.0	80	800	8,000	80,000	800,000	8,000,000	80,000,000	800,000,000
y	0.9	9.0	90	900	9,000	90,000	900,000	9,000,000	90,000,000	900,000,000

Tape & Reel Packaging Information

KEMET offers multilayer ceramic chip capacitors packaged in 8 and 12 mm tape on 7" reels in accordance with EIA Standard 481. This packaging system is compatible with all tape-fed automatic pick and place systems.

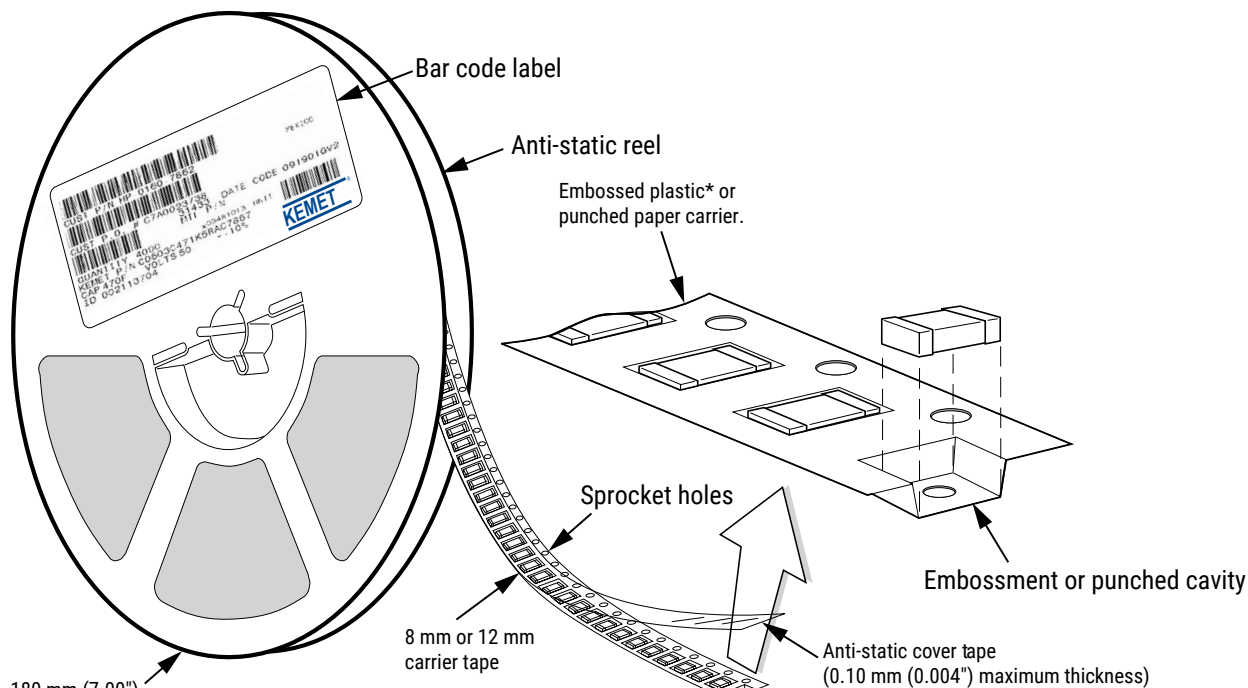

*EIA 0402 and 0603 case sizes available on punched paper only.

Table 4 – Carrier Tape Configuration, Embossed Plastic & Punched Paper (mm)

EIA Case Size	Tape size (W)*	Embossed Plastic	Punched Paper
		7" Reel	7" Reel
		Pitch (P1)*	Pitch (P1)*
0402	8		2
0603	8		2/4
0805	8	4	4
1206 – 1210	8	4	4
≥ 1812	12	8	

*Refer to Figures 1 and 2 for W and P₁ carrier tape reference locations.

*Refer to Tables 6 and 7 for tolerance specifications.

Figure 1 – Embossed (Plastic) Carrier Tape Dimensions

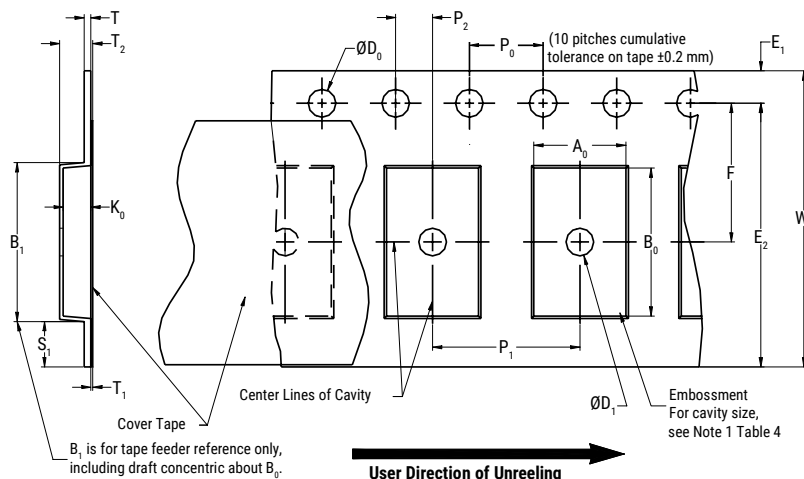

Table 5 – Embossed (Plastic) Carrier Tape Dimensions

Metric will govern

Constant Dimensions – Millimeters (Inches)									
Tape Size	D ₀	D ₁ Minimum Note 1	E ₁	P ₀	P ₂	R Reference Note 2	S ₁ Minimum Note 3	T Maximum	T ₁ Maximum
8 mm	1.5 +0.10/-0.0 (0.059 +0.004/-0.0)	1.0 (0.039)	1.75 ±0.10 (0.069 ±0.004)	4.0 ±0.10 (0.157 ±0.004)	2.0 ±0.05 (0.079 ±0.002)	25.0 (0.984)	0.600 (0.024)	0.600 (0.024)	0.100 (0.004)
12 mm		1.5 (0.059)				30 (1.181)			
Variable Dimensions – Millimeters (Inches)									
Tape Size	Pitch	B ₁ Maximum Note 4	E ₂ Minimum	F	P ₁	T ₂ Maximum	W Maximum	A ₀ , B ₀ and K ₀	
8 mm	Single (4 mm)	4.35 (0.171)	6.25 (0.246)	3.5 ±0.05 (0.138 ±0.002)	4.0 ±0.10 (0.157 ±0.004)	2.5 (0.098)	8.3 (0.327)	Note 5	
12 mm	Single (4 mm) and Double (8 mm)	8.2 (0.323)	10.25 (0.404)	5.5 ±0.05 (0.217 ±0.002)	8.0 ±0.10 (0.315 ±0.004)	4.6 (0.181)	12.3 (0.484)		

1. The embossment hole location shall be measured from the sprocket hole controlling the location of the embossment. Dimensions of the embossment location and the hole location shall be applied independent of each other.
2. The tape with or without components, shall pass around R without damage (see Figure 6).
3. If S₁ < 1.0 mm, there may not be enough area for cover tape to be properly applied (see EIA Document 481 paragraph 4.3 (b)).
4. B₁ dimension is a reference dimension for a tape feeder clearance only.
5. The cavity defined by A₀, B₀ and K₀ shall surround the component with sufficient clearance that:
 - (a) The component does not protrude above the top surface of the carrier tape.
 - (b) The component can be removed from the cavity in a vertical direction without mechanical restriction, after the top cover tape has been removed.
 - (c) Rotation of the component is limited to 20° maximum for 8 and 12 mm tapes; 10° maximum for 16 mm tapes (see Figure 3).
 - (d) Lateral movement of the component is restricted to 0.5 mm maximum for 8 mm and 12 mm wide tape; to 1.0 mm maximum for 16 mm tape (see Figure 4).
 - (e) See addendum in EIA Document 481 for standards relating to more precise taping requirements.

Figure 2 – Punched (Paper) Carrier Tape Dimensions

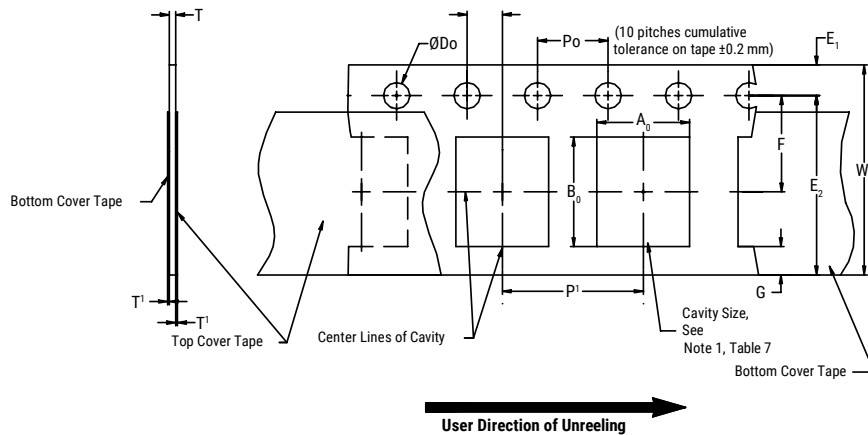

Table 6 – Punched (Paper) Carrier Tape Dimensions

Metric will govern

Constant Dimensions – Millimeters (Inches)							
Tape Size	D_0	E_1	P_0	P_2	T_1 Maximum	G Minimum	R Reference Note 2
8 mm	$1.5 + 0.10/-0.0$ (0.059 + 0.004/-0.0)	1.75 ± 0.10 (0.069 ± 0.004)	4.0 ± 0.10 (0.157 ± 0.004)	2.0 ± 0.05 (0.079 ± 0.002)	0.100 (0.004)	0.75 (0.030)	25.0 (0.984)
Variable Dimensions – Millimeters (Inches)							
Tape Size	Pitch	E_2 Minimum	F	P_1	T Maximum	W Maximum	A_0 and B_0
8 mm	Half (2 mm)	6.25 (0.246)	3.5 ± 0.05 (0.138 ± 0.002)	2.0 ± 0.05 (0.079 ± 0.002)	1.1 (0.098)	8.3 (0.327)	Note 1
8 mm	Single (4 mm)			4.0 ± 0.10 (0.157 ± 0.004)			

- The cavity defined by A_0 , B_0 and T shall surround the component with sufficient clearance that:
 - the component does not protrude beyond either surface of the carrier tape.
 - the component can be removed from the cavity in a vertical direction without mechanical restriction, after the top cover tape has been removed.
 - rotation of the component is limited to 20° maximum (see Figure 3).
 - lateral movement of the component is restricted to 0.5 mm maximum (see Figure 4).
 - see Addendum in EIA Standard 481 for standards relating to more precise taping requirements.
- The tape with or without components shall pass around R without damage (see Figure 6).

Packaging Information Performance Notes

- 1. Cover Tape Break Force:** 1.0 kg minimum.
- 2. Cover Tape Peel Strength:** The total peel strength of the cover tape from the carrier tape shall be:

Tape Width	Peel Strength
8 mm	0.1 to 1.0 Newton (10 to 100 gf)
12 and 16 mm	0.1 to 1.3 Newton (10 to 130 gf)

The direction of the pull shall be opposite the direction of the carrier tape travel. The pull angle of the carrier tape shall be 165° to 180° from the plane of the carrier tape. During peeling, the carrier and/or cover tape shall be pulled at a velocity of 300 ±10 mm/minute.

- 3. Labeling:** Bar code labeling (standard or custom) shall be on the side of the reel opposite the sprocket holes. Refer to EIA Standards 556 and 624.

Figure 3 – Maximum Component Rotation



Figure 4 – Maximum Lateral Movement



Figure 5 – Bending Radius

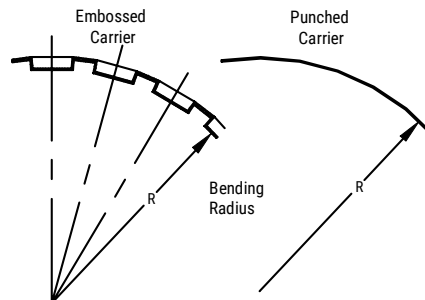

Figure 6 – Reel Dimensions



Note: Drive spokes optional; if used, dimensions B and D shall apply.

Table 7 – Reel Dimensions

Metric will govern

Constant Dimensions – Millimeters (Inches)				
Tape Size	A	B Minimum	C	D Minimum
8 mm	178 ±0.20 (7.008 ±0.008)	1.5 (0.059)	13.0 + 0.5/-0.2 (0.521 + 0.02/-0.008)	20.2 (0.795)
12 mm	330 ±0.20 (13.000 ±0.008)			
Variable Dimensions – Millimeters (Inches)				
Tape Size	N Minimum See Note 2, Tables 2–3	W ₁	W ₂ Maximum	W ₃
8 mm	50 (1.969)	8.4 + 1.5/-0.0 (0.331 + 0.059/-0.0)	14.4 (0.567)	Shall accommodate tape width without interference
12 mm		12.4 + 2.0/-0.0 (0.488 + 0.078/-0.0)	18.4 (0.724)	

Figure 7 – Tape Leader & Trailer Dimensions

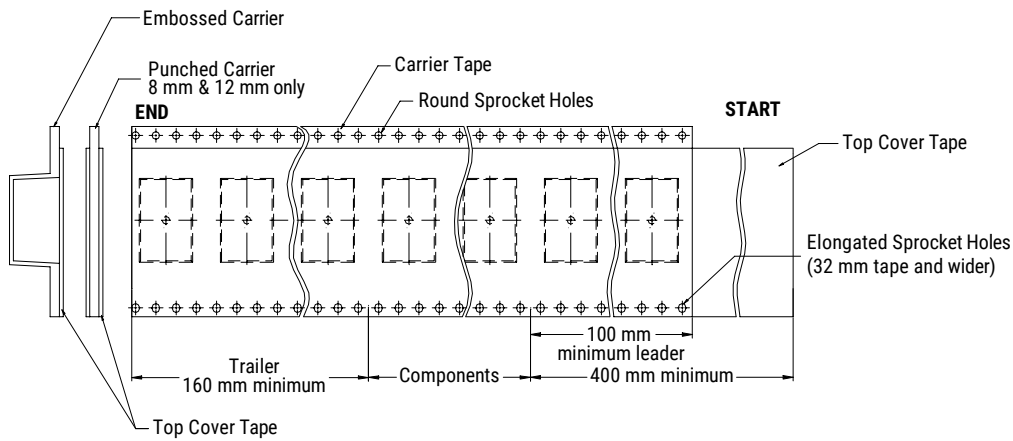
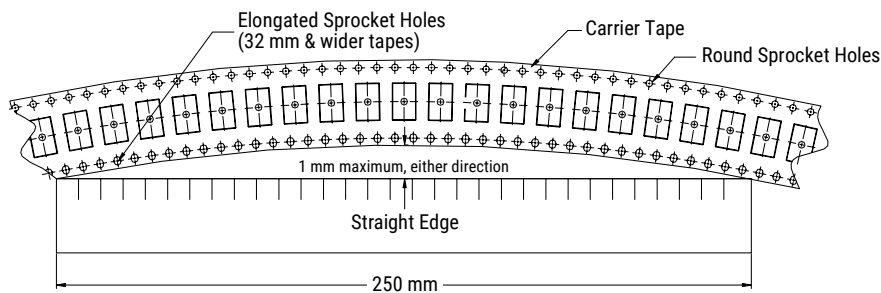

Figure 8 – Maximum Camber



Waffle Tray Packaging Information – 2" x 2" w/ Static Protection

Figure 9 – Waffle Tray Dimensions – Inches (Millimeters)

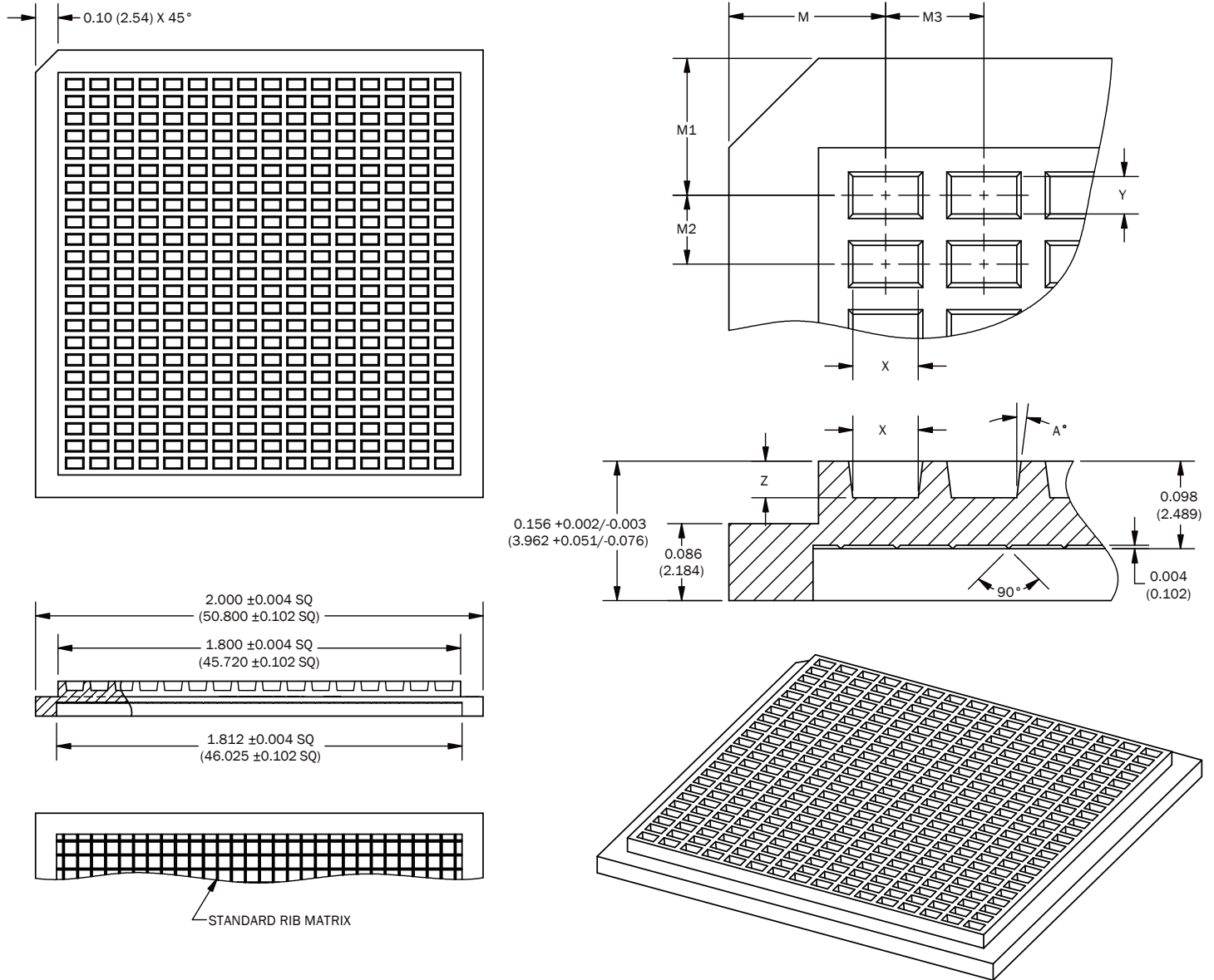

Table 8A – Waffle Tray Dimensions – Inches

Case Size		2" x 2" Waffle Tray Dimensions – Inches									Packaging Quantity (pcs/unit packaging)
		M	M1	M2	M3	X	Y	Z	A°	MATRIX	
EIA (in)	Metric (mm)	±0.003	±0.003	±0.002	±0.002	±0.002	±0.002	±0.003	±1/2°	(X x Y)	
0402	1005	0.175	0.153	0.077	0.110	0.073	0.042	0.041	7	16 X 23	368
0603	1608	0.175	0.153	0.077	0.110	0.073	0.042	0.041	7	16 X 23	368
0805	2012	0.232	0.186	0.181	0.171	0.062	0.092	0.036	10	10 X 10	100
1206 ^{1,2}	3216	0.194	0.228	0.193	0.124	0.067	0.130	0.065	5	14 X 9	126
1206 ^{1,3}	3216	0.250	0.250	0.375	0.167	0.100	0.200	0.070	5	10 X 5	50
1210	3225	0.217	0.244	0.215	0.174	0.110	0.145	0.080	5	10 X 8	80
1812	4532	0.271	0.285	0.286	0.243	0.150	0.200	0.075	5	7 X 6	42
2220	5650	0.318	0.362	0.424	0.34	0.24	0.32	0.032	5	5 X 4	20

¹ Packaging of 1206 (3216 metric) case size capacitors is dependent upon the nominal chip thickness of the device. Contact KEMET Sales for Waffle Tray quantities for specified part number.

² Assigned to 1206 (3216 metric) case size capacitors with nominal thickness of ≤ 1.25 mm (0.049 inches).

³ Assigned to 1206 (3216 metric) case size capacitors with nominal thickness of > 1.25 mm (0.049 inches).

Table 8B – Waffle Tray Dimensions – Millimeters

Case Size		2" x 2" Waffle Tray Dimensions – Millimeters									Packaging Quantity (pcs/unit packaging)
		M	M1	M2	M3	X	Y	Z	A°	MATRIX	
EIA (in)	Metric (mm)	±0.08	±0.08	±0.05	±0.05	±0.05	±0.05	±0.08	±1/2°	(X x Y)	
0402	1005	4.45	3.89	1.96	2.79	1.85	1.07	1.04	7	16 X 23	368
0603	1608	4.45	3.89	1.96	2.79	1.85	1.07	1.04	7	16 X 23	368
0805	2012	5.89	4.72	4.60	4.34	1.57	2.34	0.91	10	10 X 10	100
1206 ^{1,2}	3216	4.93	5.79	4.90	3.15	1.70	3.30	1.65	5	14 X 9	126
1206 ^{1,3}	3216	6.35	6.35	9.53	4.24	2.54	5.08	1.78	5	10 X 5	50
1210	3225	5.51	6.20	5.46	4.42	2.79	3.68	2.03	5	10 X 8	80
1812	4532	6.88	7.24	7.26	6.17	3.81	5.08	1.91	5	7 X 6	42
2220	5650	8.08	9.19	10.77	8.64	6.10	8.13	0.81	5	5 X 4	20

¹ Packaging of 1206 (3216 metric) case size capacitors is dependent upon the nominal chip thickness of the device. Contact KEMET Sales for Waffle Tray quantities for specified part number.

² Assigned to 1206 (3216 metric) case size capacitors with nominal thickness of ≤ 1.25 mm (0.049 inches).

³ Assigned to 1206 (3216 metric) case size capacitors with nominal thickness of > 1.25 mm (0.049 inches).

KEMET Electronics Corporation Sales Offices

For a complete list of our global sales offices, please visit www.kemet.com/sales.

Disclaimer

All product specifications, statements, information and data (collectively, the "Information") in this datasheet are subject to change. The customer is responsible for checking and verifying the extent to which the Information contained in this publication is applicable to an order at the time the order is placed.

All Information given herein is believed to be accurate and reliable, but it is presented without guarantee, warranty, or responsibility of any kind, expressed or implied.

Statements of suitability for certain applications are based on KEMET Electronics Corporation's ("KEMET") knowledge of typical operating conditions for such applications, but are not intended to constitute – and KEMET specifically disclaims – any warranty concerning suitability for a specific customer application or use. The Information is intended for use only by customers who have the requisite experience and capability to determine the correct products for their application. Any technical advice inferred from this Information or otherwise provided by KEMET with reference to the use of KEMET's products is given gratis, and KEMET assumes no obligation or liability for the advice given or results obtained.

Although KEMET designs and manufactures its products to the most stringent quality and safety standards, given the current state of the art, isolated component failures may still occur. Accordingly, customer applications which require a high degree of reliability or safety should employ suitable designs or other safeguards (such as installation of protective circuitry or redundancies) in order to ensure that the failure of an electrical component does not result in a risk of personal injury or property damage.

Although all product-related warnings, cautions and notes must be observed, the customer should not assume that all safety measures are indicated or that other measures may not be required.